

DVD AV CONTROL CENTER
DVR-6300

SERVICE MANUAL
(DVT-6300/7300/8300)

KENWOOD

© 2004-8 PRINTED IN KOREA
 B51-5922-00 (K/K) 746

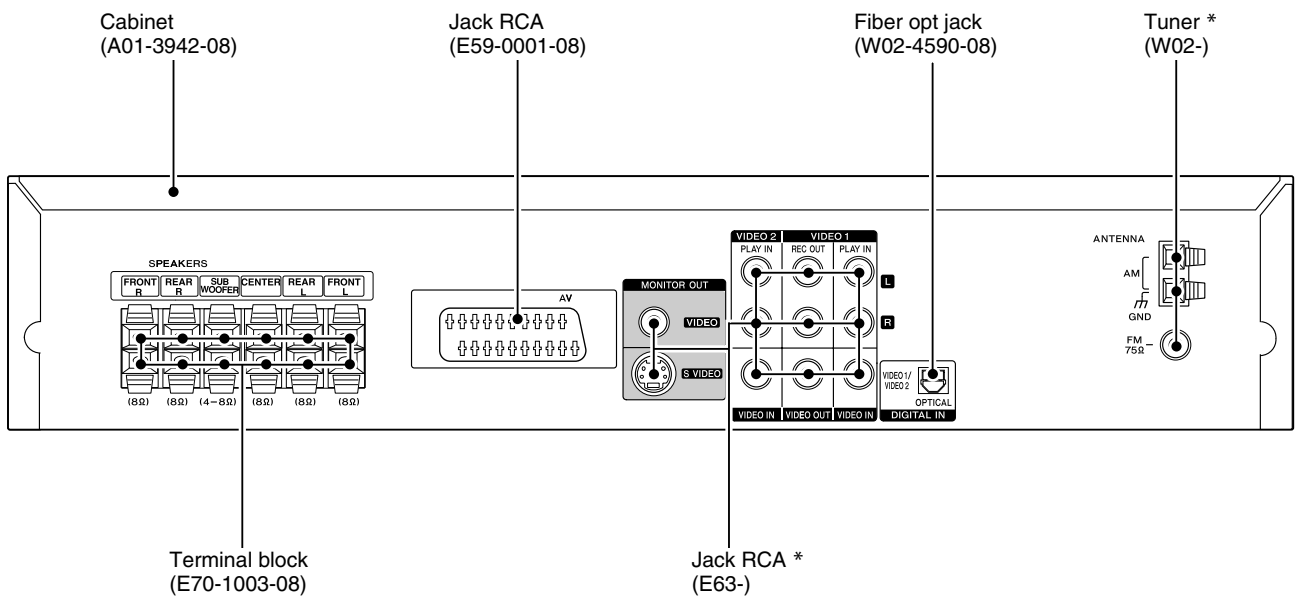
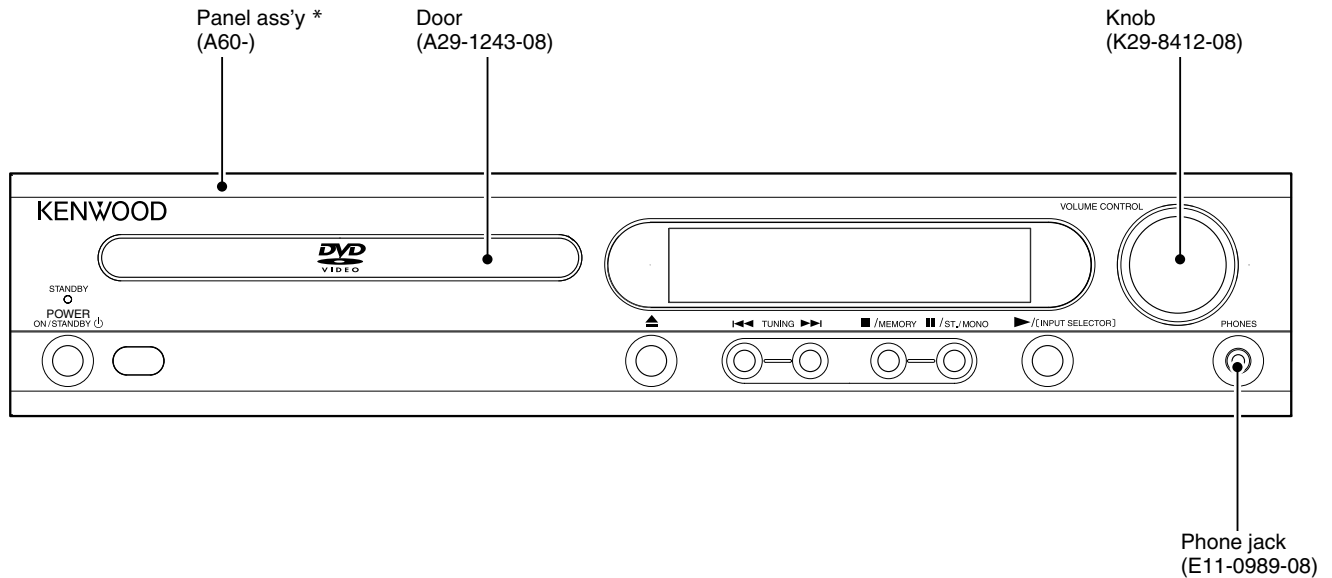

*** Refer to parts list on page 27.**

In compliance with Federal Regulations, following are reproduction of labels on, or inside the product relating to laser product safety.

Caution : No connection of ground line if disassemble the unit. Please connect the ground line on rear panel, PCBs, Chassis and some others.

KENWOOD Corp. certifies this equipment conforms to DHHS Regulations No.21 CFR 1040. 10, Chapter 1, subchapter J.
DANGER : Laser radiation when open and interlock defeated. AVOID DIRECT EXPOSURE TO BEAM.









DVR-6300

CONTENTS / ACCESSORIES / CAUTIONS

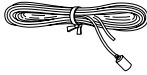
CONTENTS

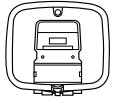
CONTENTS / ACCESSORIES / CAUTIONS.....	2	EXPLODED VIEW	25
PARTS DESCRIPTIONS	3	PARTS LIST	27
PC BOARD	4	SPECIFICATIONS	34
SCHEMATIC DIAGRAM	15		

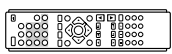
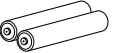
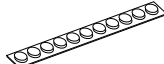
ACCESSORIES

<p>FM indoor antenna (1)</p> <p>(For Europe) (T90-0916-08)</p>  <p>(For U.S.A., Canada and Australia) (T90-0915-08)</p> 	<p>Loop antenna (1) (T90-0917-08)</p> 	<p>Accessories for speaker part (For DVT-6300 and DVT-7300) Speaker cords (6) *</p> <table border="1" style="margin-left: auto; margin-right: auto;"> <thead> <tr> <th></th> <th>Length</th> </tr> </thead> <tbody> <tr> <td>For Front (2)</td> <td>4.5 m (177-3/16")</td> </tr> <tr> <td>For Center (1)</td> <td>3 m (118-1/8")</td> </tr> <tr> <td>For Rear (2)</td> <td>8 m (314-15/16")</td> </tr> <tr> <td>For Subwoofer (1)</td> <td>4.5 m (177-3/16")</td> </tr> </tbody> </table>		Length	For Front (2)	4.5 m (177-3/16")	For Center (1)	3 m (118-1/8")	For Rear (2)	8 m (314-15/16")	For Subwoofer (1)	4.5 m (177-3/16")
	Length											
For Front (2)	4.5 m (177-3/16")											
For Center (1)	3 m (118-1/8")											
For Rear (2)	8 m (314-15/16")											
For Subwoofer (1)	4.5 m (177-3/16")											
<p>Video cord (Yellow)(1) (E30-7341-08)</p> 	<p>Remote control unit (1) (A70-1685-08)</p> 	<p>Batteries (R03/AAA) (2)</p> 										
		<p>Cushion (15) *</p> <p>(Small : 11 pcs 1 sheet) (Big : 4 pcs 1 sheet)</p>  										

* See speaker's manual.

SYSTEM CONFIGURATIONS

SYSTEM	RECEIVER	SPEAKER	SPEAKER
DVT-6300-H	DVR-6300	KSW-6300-H	-
DVT-6300-S	DVR-6300	KSW-6300-S	-
DVT-7300	DVR-6300	KSW-7300	-
DVT-8300	DVR-6300	KS-908HT	SW-18HT

CAUTIONS

Operation to reset

The microprocessor may fall into malfunction (impossibility to operate erroneous display, etc.) when the power cord is unplugged while power is ON or due to an external factor.
In this case, switch off the power, wait for several seconds, and then switch the power on again.

For the U.S.A.

CAUTION:

Use of controls or adjustments or performance of procedures other than those specified herein may result in hazardous radiation exposure.
In compliance with Federal Regulations, the following are reproductions of labels on, or inside the product relating to laser product safety.

KENWOOD CORPORATION
2967-3, ISHIKAWA-CHO,
HACHIOJI-SHI,
TOKYO, JAPAN

KENWOOD CORP. CERTIFIES THIS EQUIPMENT
CONFORMS TO DHHS REGULATIONS NO. 21 CFR
1040.10, CHAPTER 1, SUBCHAPTER J.

Location: Back Panel

For the U.S.A.

Note to CATV system installer

This reminder is provided to call the CATV system installer's attention to Article 820-40 of the NEC that provides guidelines for proper grounding and, in particular, specifies that the cable ground shall be connected to the grounding system of the building, as close to the point of cable entry as practical.

For Canada

NOTICE: This Class B digital apparatus complies with Canadian ICES-003.

Note related to transportation and movement

Before transporting or moving this unit, carry out the following operations.

1. Set the POWER ON/OFF switch to the ON without loading a disc.
2. Wait a few seconds and verify that the display shown appears.

"NO DISC"

3. Set the POWER ON/OFF switch to OFF.

Caution on condensation

Condensation (of dew) may occur inside the unit when there is a great difference in temperature between this unit and the outside. This unit may not function properly if condensation occurs. In this case, leave the unit for a few hours and restart the operation after the condensation has dried up.

Be specially cautious against condensation in the following circumstances:

When this unit is carried from one place to another across a large difference in temperature, when the humidity in the room where this unit is installed increases, etc.

The marking of products using lasers (For countries other than U.S.A. and Canada)

CLASS 1
LASER PRODUCT

The marking this product has been classified as Class 1. It means that there is no danger of hazardous radiation outside the product.

Location: Back panel

PARTS DESCRIPTIONS

CAPACITORS

CC 45 TH 1H 220 J
 1 2 3 4 5 6

- 1 = Type ... ceramic, electrolytic, etc.
- 2 = Shape ... round, square, ect.
- 3 = Temp. coefficient
- 4 = Voltage rating
- 5 = Value
- 6 = Tolerance

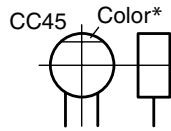

Capacitor value

- 010 = 1pF
- 100 = 10pF
- 101 = 100pF
- 102 = 1000pF = 0.001μF
- 103 = 0.01μF

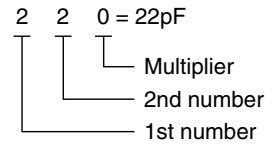

Temperature coefficient

1st Word	C	L	P	R	S	T	U
Color*	Black	Red	Orange	Yellow	Green	Blue	Violet
ppm/°C	0	-80	-150	-220	-330	-470	-750

2nd Word	G	H	J	K	L
ppm/°C	±30	±60	±120	±250	±500

Example : CC45TH = -470 ± 60ppm/°C

Tolerance (More than 10pF)

Code	C	D	G	J	K	M	X	Z	P	No code
(%)	±0.25	±0.5	±2	±5	±10	±20	+40	+80	+100	More than 10μF - 10 ~ +50
							-20	-20	-0	Less than 4.7μF - 10 ~ +75

(Less than 10pF)

Code	B	C	D	F	G
(pF)	±0.1	±0.25	±0.5	±1	±2

Voltage rating

2nd word	A	B	C	D	E	F	G	H	J	K	V	
1st word	0	1.0	1.25	1.6	2.0	2.5	3.15	4.0	5.0	6.3	8.0	-
	1	10	12.5	16	20	25	31.5	40	50	63	80	35
	2	100	125	160	200	250	315	400	500	630	800	-
	3	1000	1250	1600	2000	2500	3150	4000	5000	6300	8000	-

Chip capacitors

(EX) CC 7 3 F SL 1 H 0 0 0 J
 1 2 3 4 5 6 7

(Chip)(CH, RH, UJ, SL)

(EX) CK 7 3 F F 1 H 0 0 0 Z
 1 2 3 4 5 6 7

(Chip)(B, F)

Refer to the table above.

- 1 = Type
- 2 = Shape
- 3 = Dimension
- 4 = Temp. coefficient
- 5 = Voltage rating
- 6 = Value
- 7 = Tolerance

Dimension (Chip capacitors)

Dimension code	L	W	T
Empty	5.6 ± 0.5	5.0 ± 0.5	Less than 2.0
A	4.5 ± 0.5	3.2 ± 0.4	Less than 2.0
B	4.5 ± 0.5	2.0 ± 0.3	Less than 2.0
C	4.5 ± 0.5	1.25 ± 0.2	Less than 1.25
D	3.2 ± 0.4	2.5 ± 0.3	Less than 1.5
E	3.2 ± 0.2	1.6 ± 0.2	Less than 1.25
F	2.0 ± 0.3	1.25 ± 0.2	Less than 1.25
G	1.6 ± 0.2	0.8 ± 0.2	Less than 1.0

RESISTORS

Chip resistor (Carbon)

(EX) RK 7 3 E B 2 B 0 0 0 J
 1 2 3 4 5 6 7

(Chip)(B,F)

Dimension

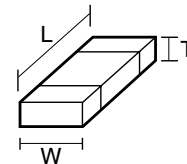

Carbon resistor (Normal type)

(EX) RD 1 4 B B 2 C 0 0 0 J
 1 2 3 4 5 6 7

- 1 = Type
- 2 = Shape
- 3 = Dimension
- 4 = Temp. coefficient
- 5 = Rating wattage
- 6 = Value
- 7 = Tolerance

Dimension (Chip resistor)

Dimension code	L	W	T
E	3.2 ± 0.2	1.6 ± 0.2	1.0
F	2.0 ± 0.3	1.25 ± 0.2	1.0
G	1.6 ± 0.2	0.8 ± 0.2	0.5 ± 0.1

Rating wattage

Code	Wattage	Code	Wattage	Code	Wattage
1J	1/16W	2C	1/6W	3A	1W
2A	1/10W	2E	1/4W	3D	2W
2B	1/8W	2H	1/2W		

PC BOARD(Component side view)

SMPS

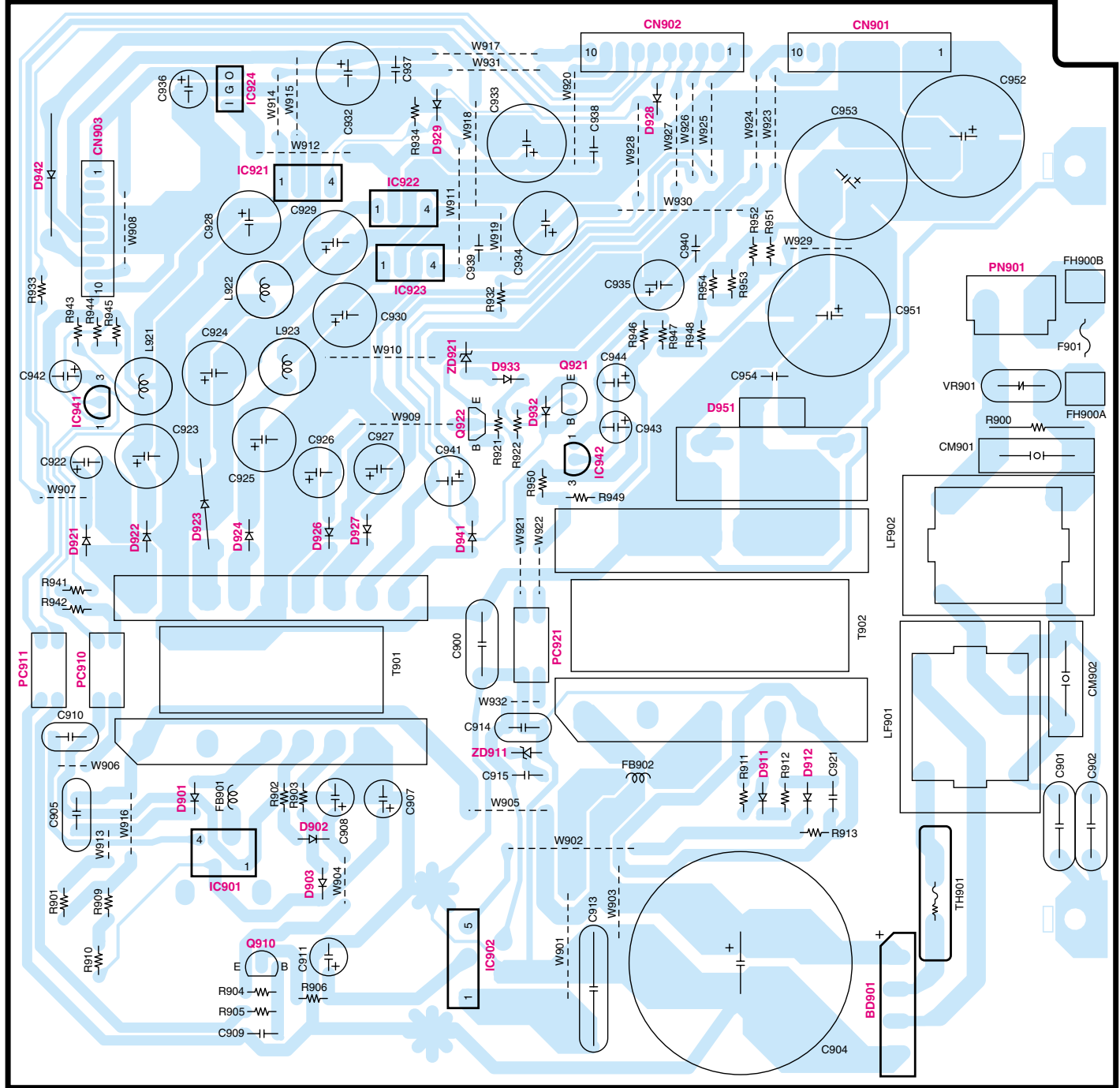

PC BOARD(Component side view)

DVD

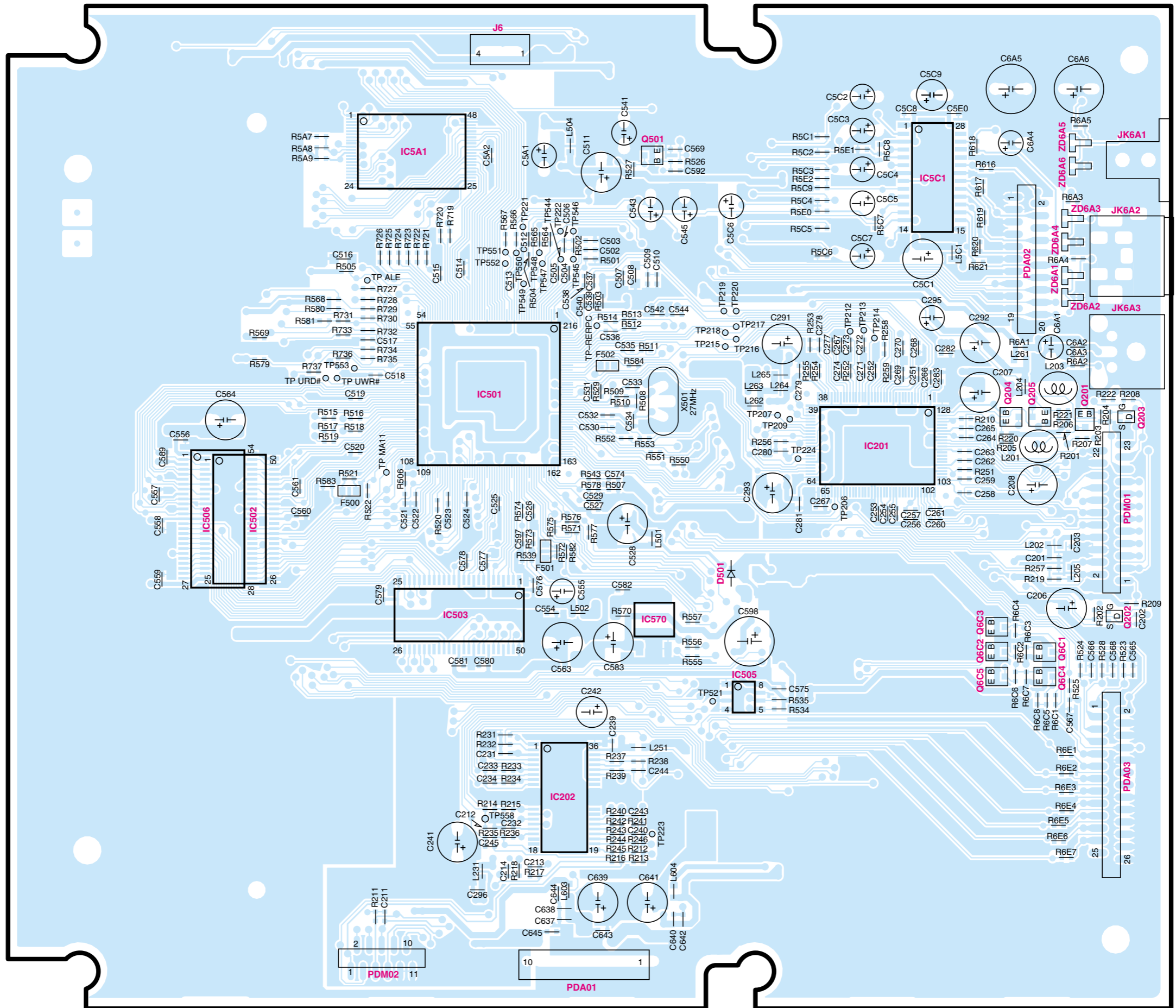

Refer to the schematic diagram for the value of resistors and capacitors.

PC BOARD(Foil side view)

DVD

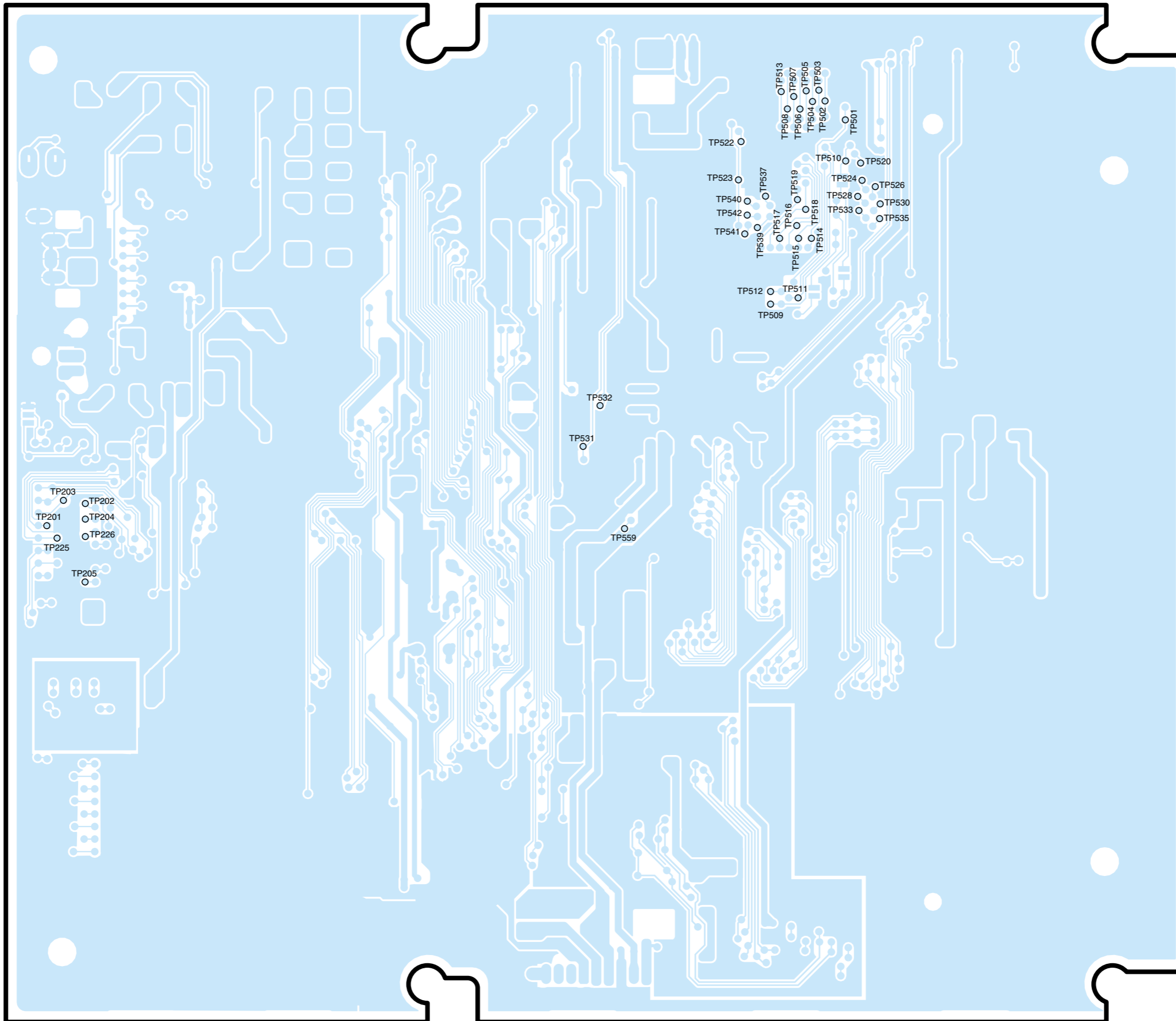

TP203
TP201
TP225
TP205
TP202
TP204
TP226

TP522
TP523
TP540
TP542
TP541
TP539
TP517
TP516
TP515
TP514
TP512
TP511
TP509

TP532
TP531
TP559

TP508
TP506
TP504
TP502
TP501
TP510
TP520
TP524
TP528
TP533
TP518
TP519
TP513
TP507
TP505
TP503

TP526
TP530
TP535

Refer to the schematic diagram for the value of resistors and capacitors.

PC BOARD(Component side view)

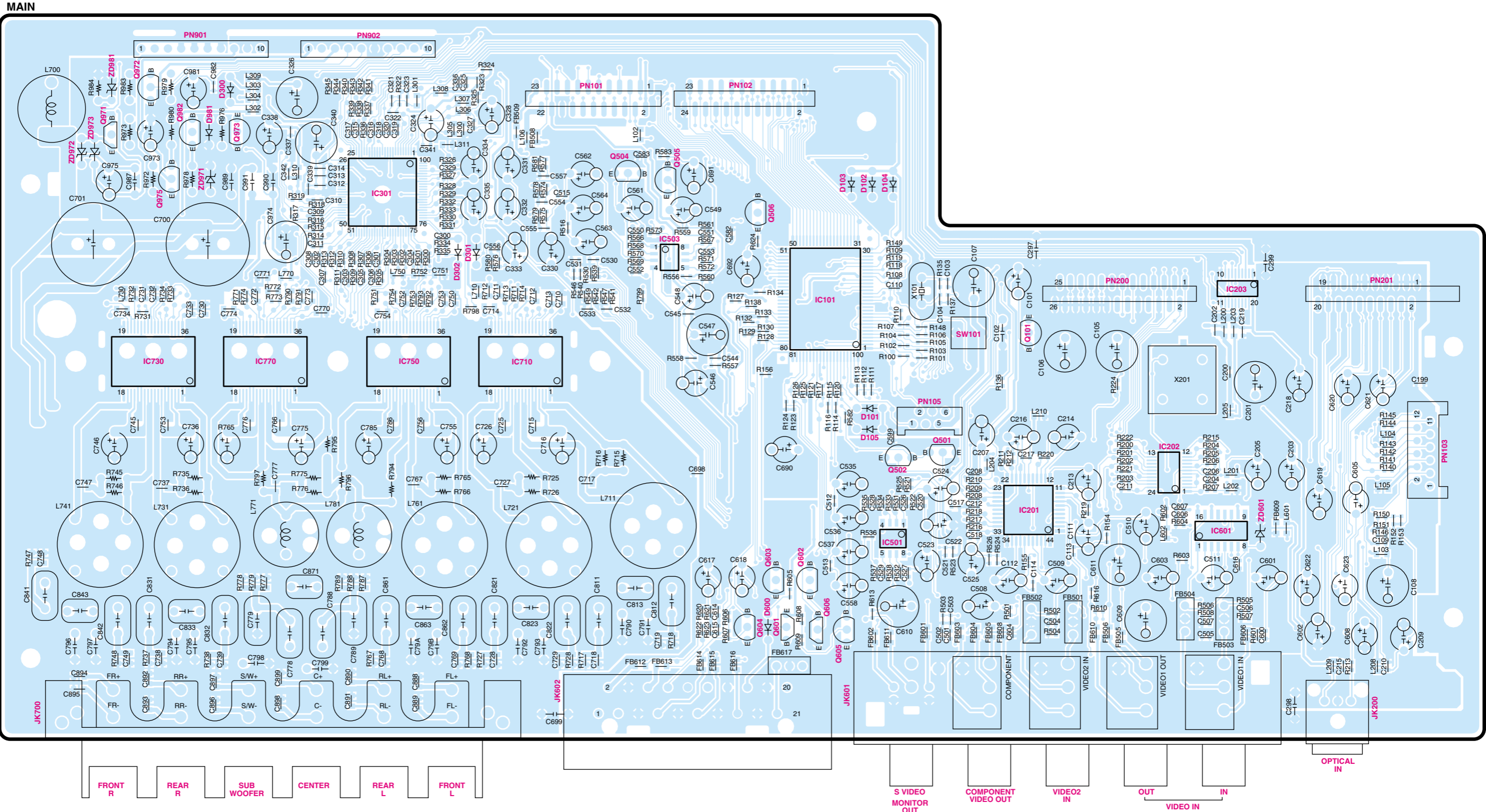

Refer to the schematic diagram for the value of resistors and capacitors.

PC BOARD(Foil side view)

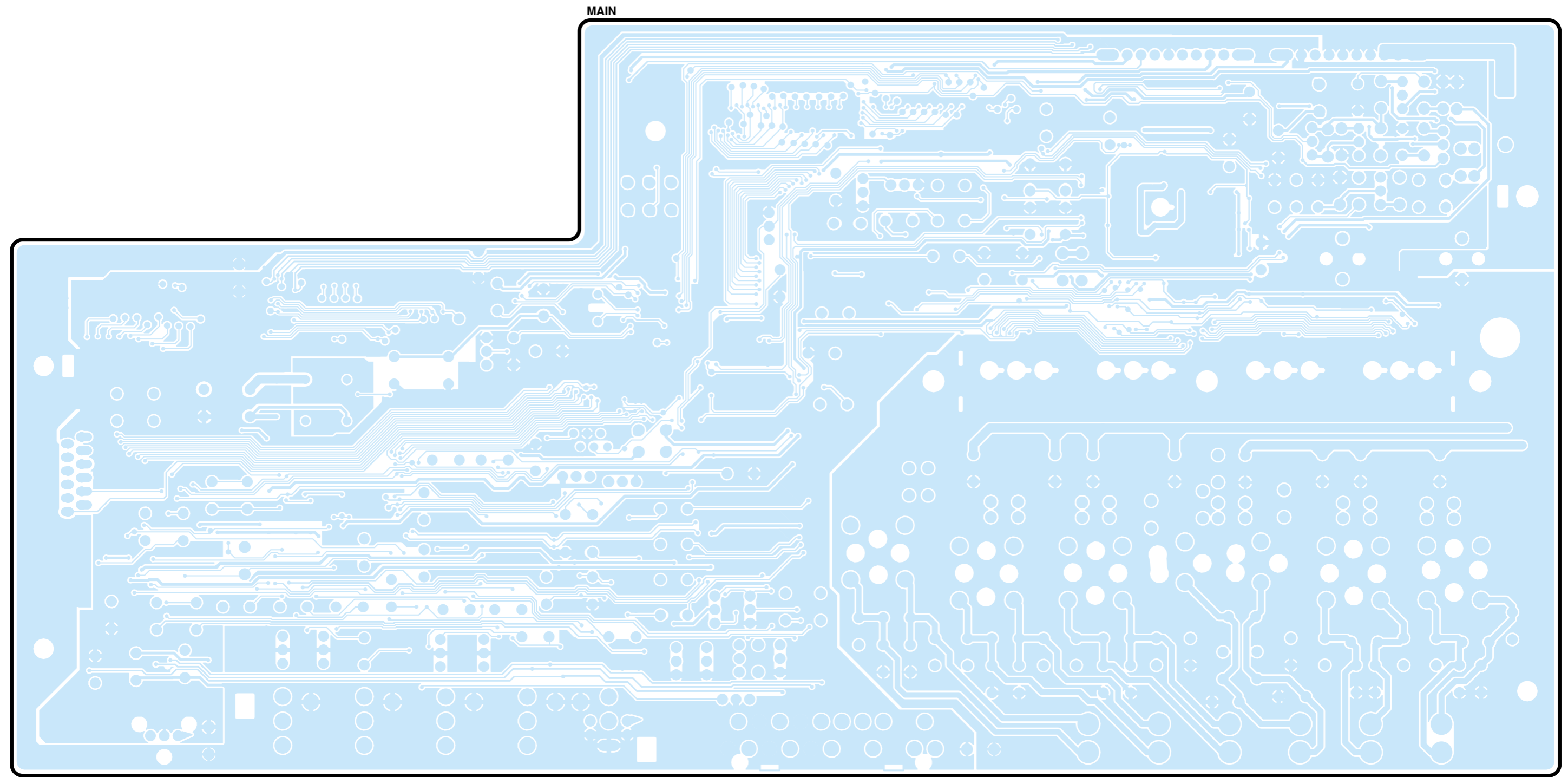

PC BOARD

Component side view

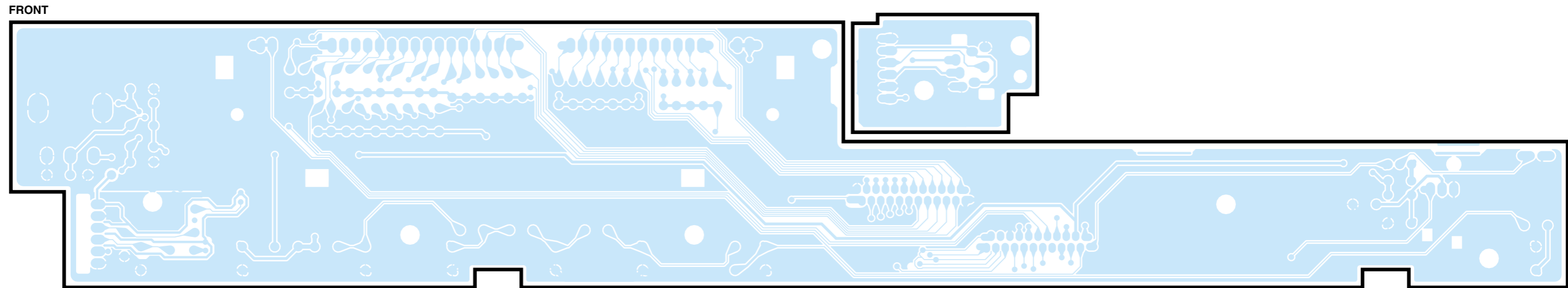
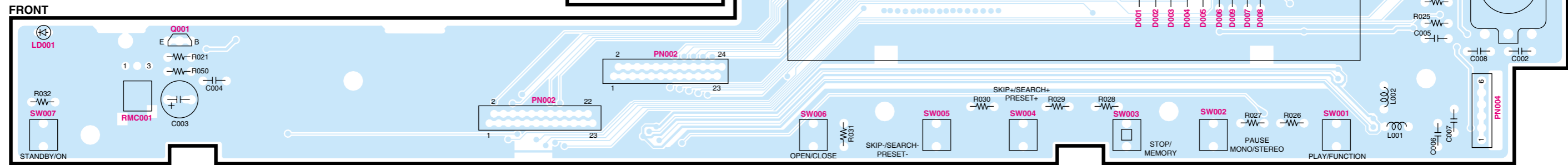

Foil side view

DVR-6300

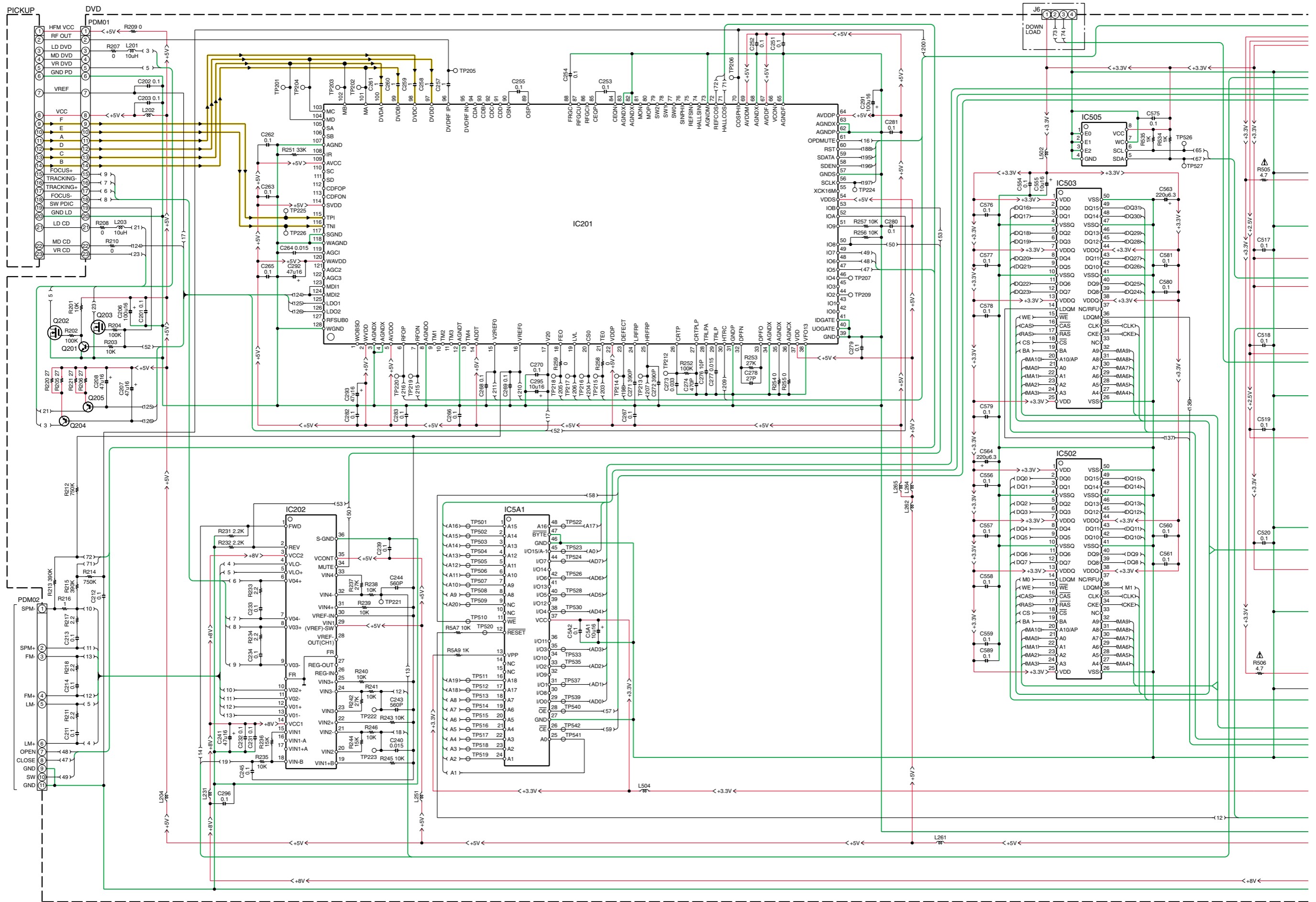

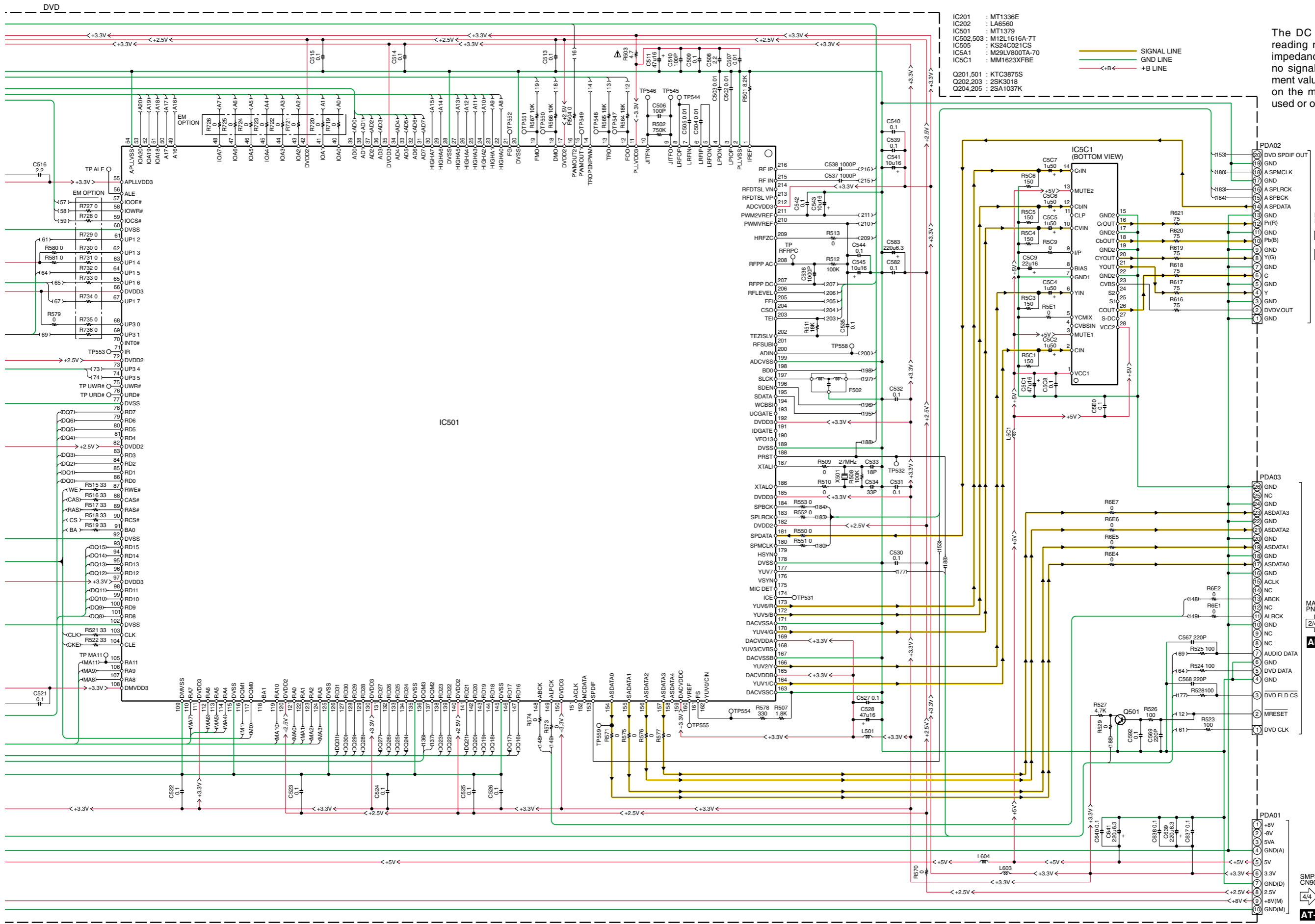

- IC201 : MT1336E
- IC202 : LA6560
- IC501 : MT13379
- IC502,503 : M12L1616A-7T
- IC505 : KS24C021CS
- IC5A1 : M29LV800TA-70
- IC5C1 : MM1623XFBE
- Q201,501 : KTC3875S
- Q202,203 : 2SK3018
- Q204,205 : 2SA1037K

— SIGNAL LINE
— GND LINE
— +B LINE

The DC voltage is an actual reading measured with a high impedance type voltmeter with no signal input. The measurement value may vary depending on the measuring instruments used or on the product.

MAIN-PN201
2/4
X-7

CAUTION: For continued safety, replace safety critical components only with manufacturer's recommended parts (refer to parts list). ⚠ indicates safety critical components. For continued protection against risk of fire, replace only with same type and rating fuse(s). To reduce the risk of electric shock, leakage-current or resistance measurements shall be carried out (exposed parts are acceptably insulated from the supply circuit) before the appliance is returned to the customer.

MAIN-PN200
2/4
AF-1

SMPS-CN903
4/4
AT-2

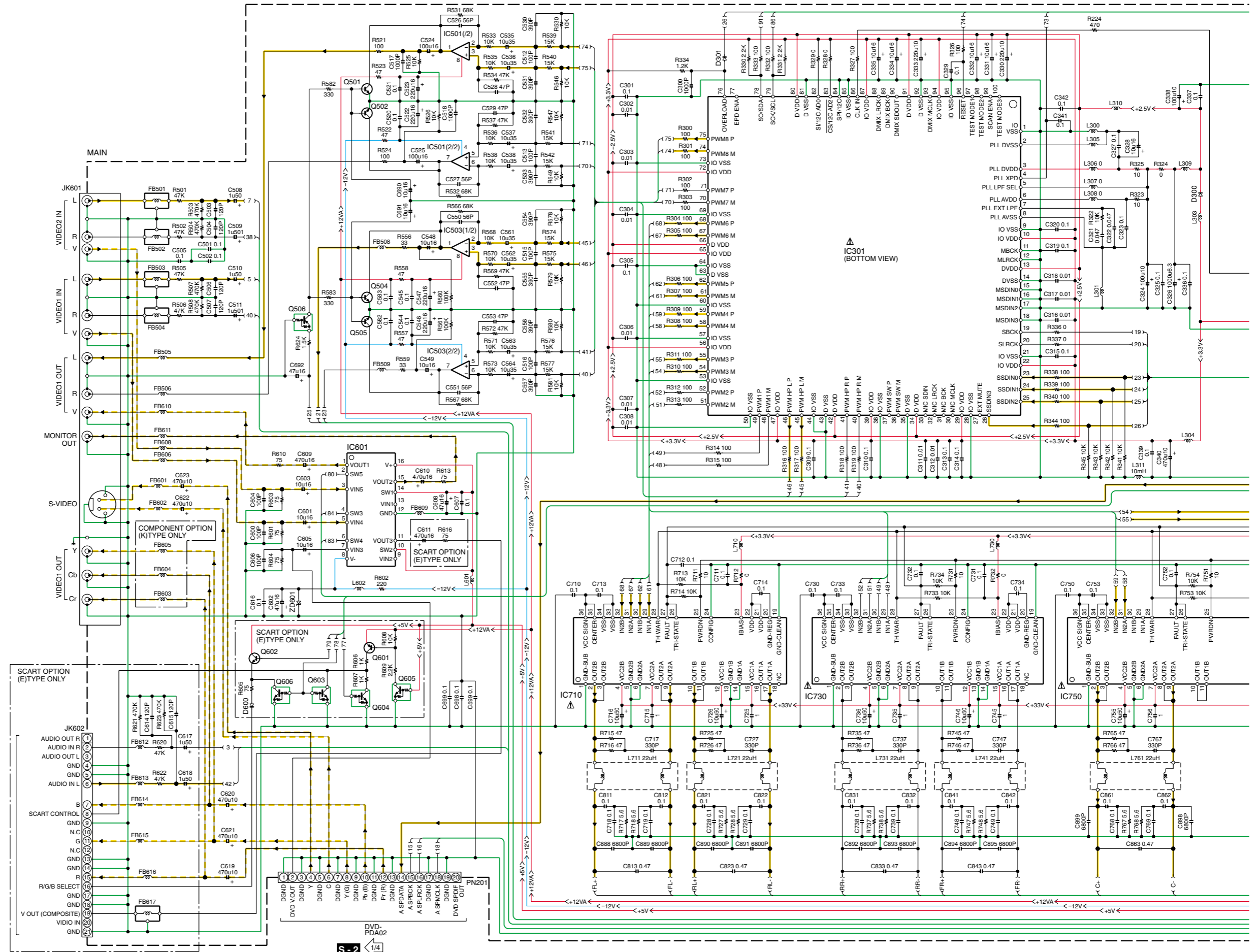

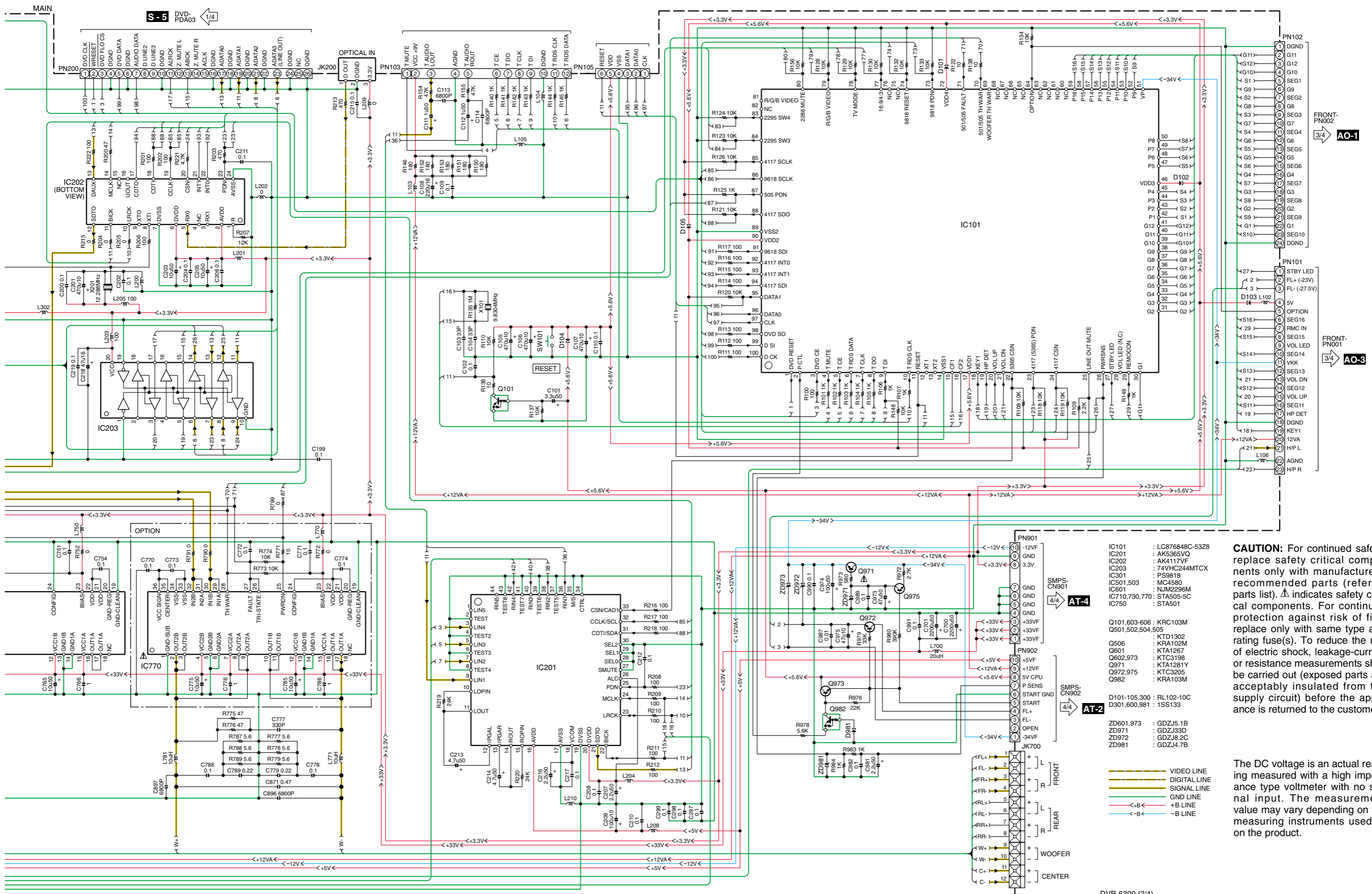

- IC101** : LC876848C-532B
IC201 : AK5365VQ
IC202 : AK4117VF
IC203 : 74VHC244MTCX
IC301 : PS9818
IC501,503 : MC4580
IC601 : NJM2296M
IC710,730,770 : STA505-5C
IC750 : STA501
- Q101,603-606** : KRC103M
Q501,502,504,505 : KTD1302
Q506 : KRA102M
Q601 : KTA1267
Q602,973 : KTC3198
Q971 : KTA1281Y
Q972,975 : KTC3205
Q982 : KRA103M
- D101-105,300** : RL102-10C
D301,600,981 : 1SS133
- ZD601,973** : GDZJ5.1B
ZD971 : GDZJ33D
ZD972 : GDZJ8.2C
ZD981 : GDZJ4.7B

CAUTION: For continued safety, replace safety critical components only with manufacturer's recommended parts (refer to parts list). Δ indicates safety critical components. For continued protection against risk of fire, replace only with same type and rating fuse(s). To reduce the risk of electric shock, leakage-current or resistance measurements shall be carried out (exposed parts are acceptably insulated from the supply circuit) before the appliance is returned to the customer.

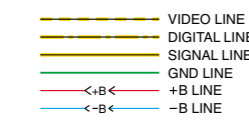

DVR-6300 (2/4)

DVR-6300

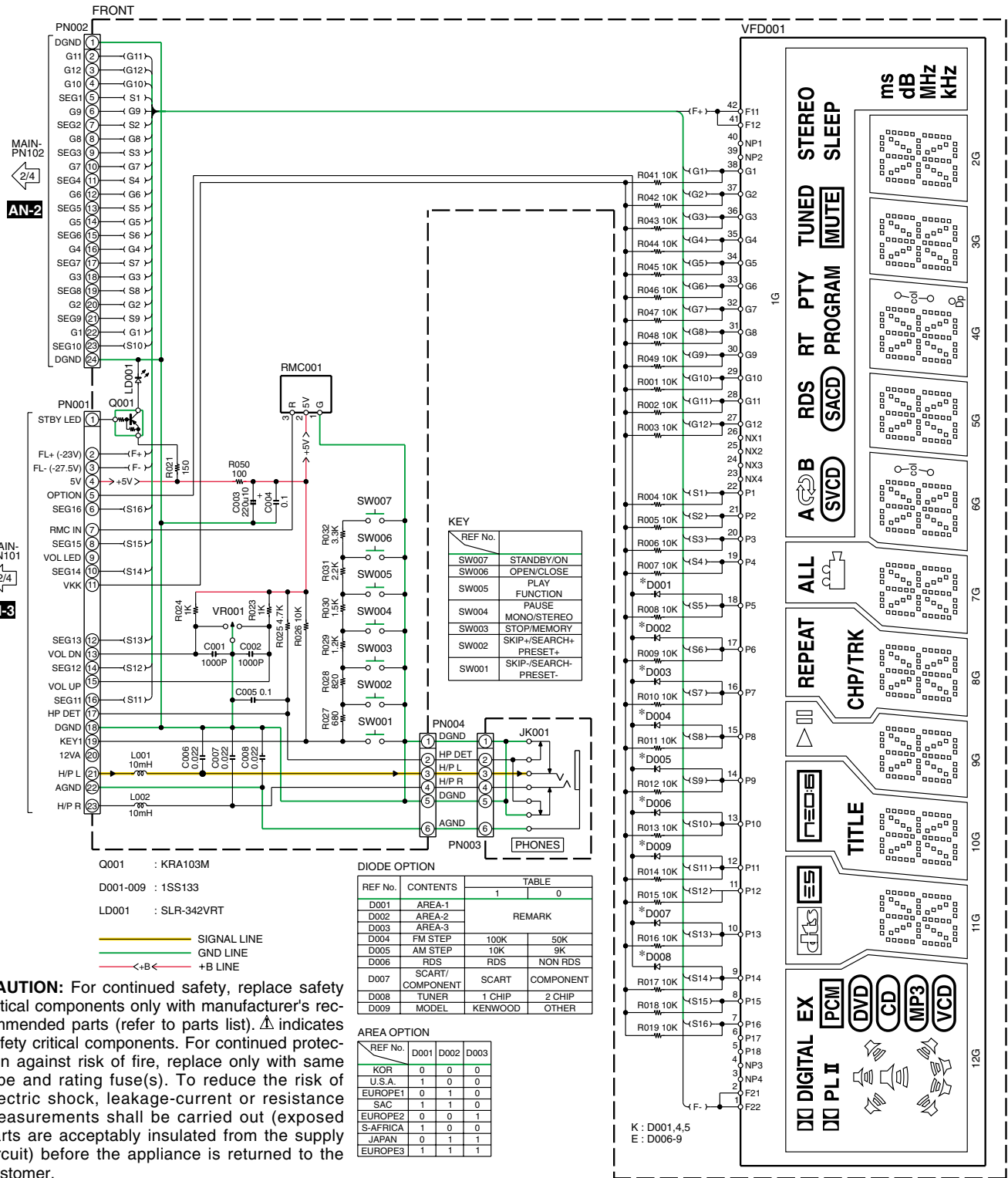

CAUTION: For continued safety, replace safety critical components only with manufacturer's recommended parts (refer to parts list). Δ indicates safety critical components. For continued protection against risk of fire, replace only with same type and rating fuse(s). To reduce the risk of electric shock, leakage-current or resistance measurements shall be carried out (exposed parts are acceptably insulated from the supply circuit) before the appliance is returned to the customer.

The DC voltage is an actual reading measured with a high impedance type voltmeter with no signal input. The measurement value may vary depending on the measuring instruments used or on the product.

	12G	11G	10G	9G	8G	7G	6G	5G	4G	3G	2G	1G
P1	DI DIGITAL	DI	REPEAT	ALL	col	col	col	col	col	col	col	A
P2	EX	TITLE	CHP/TRK									B
P3	PL II	d	d	d	d	d	d	d	d	d	d	RDS
P4	PCM	p	p	p	p	p	p	p	p	p	p	RT
P5	DVD	n	n	n	n	n	n	n	n	n	n	PTY
P6	CD	r	r	r	r	r	r	r	r	r	r	TUNED
P7	MP3	e	e	e	e	e	e	e	e	e	e	STEREO
P8	VCD	c	c	c	c	c	c	c	c	c	c	SACD
P9	S1	m	m	m	m	m	m	m	m	m	m	PROGRAM
P10	S2	g	g	g	g	g	g	g	g	g	g	MUTE
P11	S3	f	f	f	f	f	f	f	f	f	f	SLEEP
P12	S4	b	b	b	b	b	b	b	b	b	b	SLEEP
P13	S5	k	k	k	k	k	k	k	k	k	k	ms
P14	S6	h	h	h	h	h	h	h	h	h	h	dB
P15	S7	j	j	j	j	j	j	j	j	j	j	MHz
P16	S8	a	a	a	a	a	a	a	a	a	a	kHz

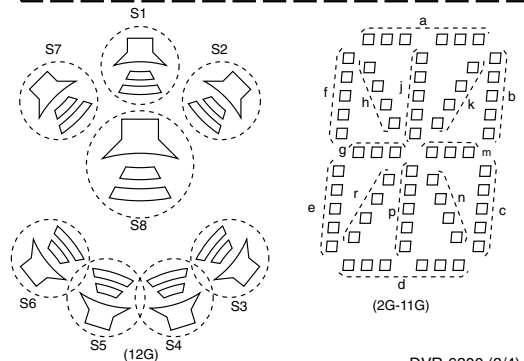

DVR-6300

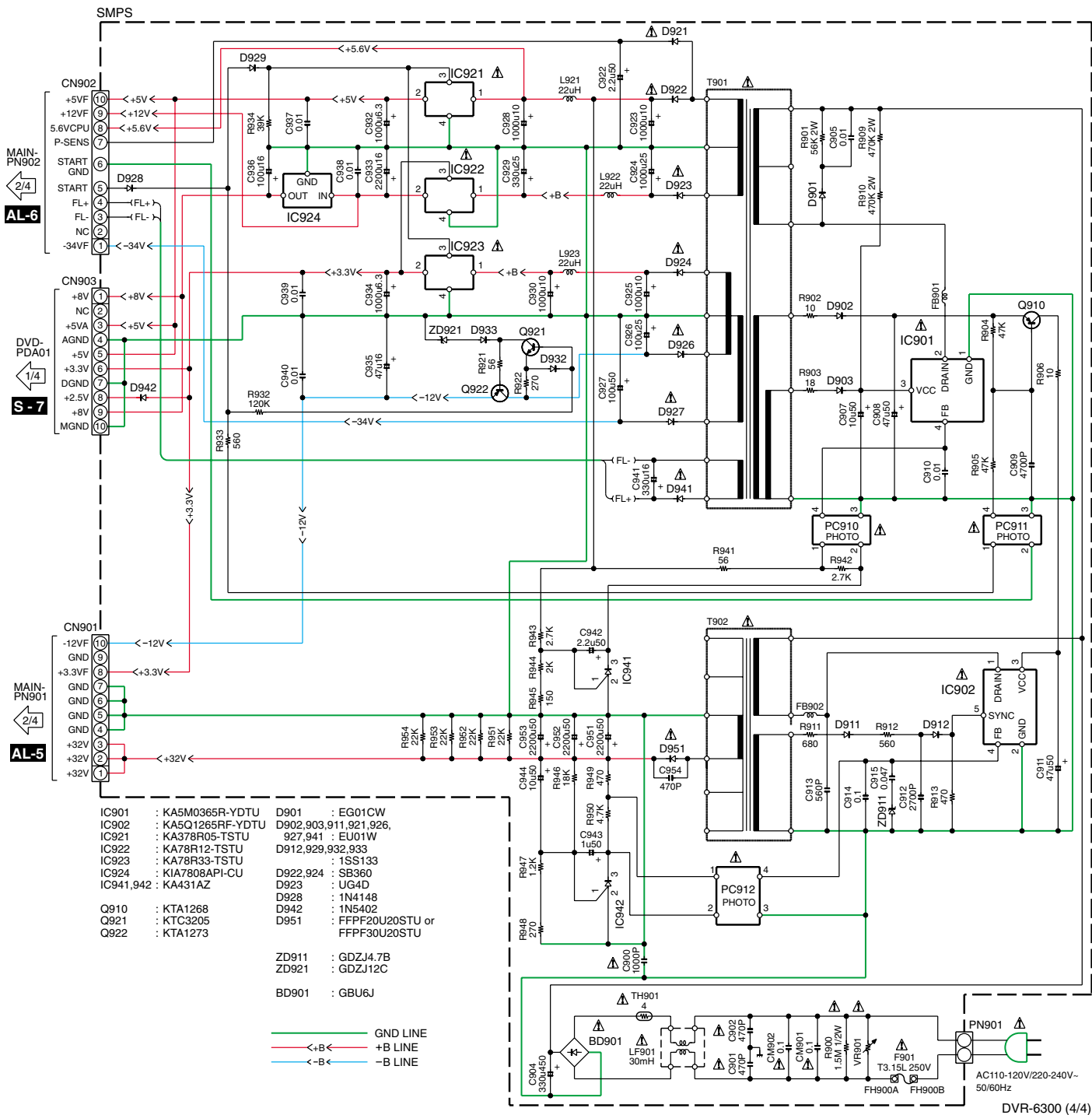

CAUTION: For continued safety, replace safety critical components only with manufacturer's recommended parts (refer to parts list). Δ indicates safety critical components. For continued protection against risk of fire, replace only with same type and rating fuse(s). To reduce the risk of electric shock, leakage-current or resistance measurements shall be carried out (exposed parts are acceptably insulated from the supply circuit) before the appliance is returned to the customer.

The DC voltage is an actual reading measured with a high impedance type voltmeter with no signal input. The measurement value may vary depending on the measuring instruments used or on the product.

EXPLODED VIEW (MECHANISM)

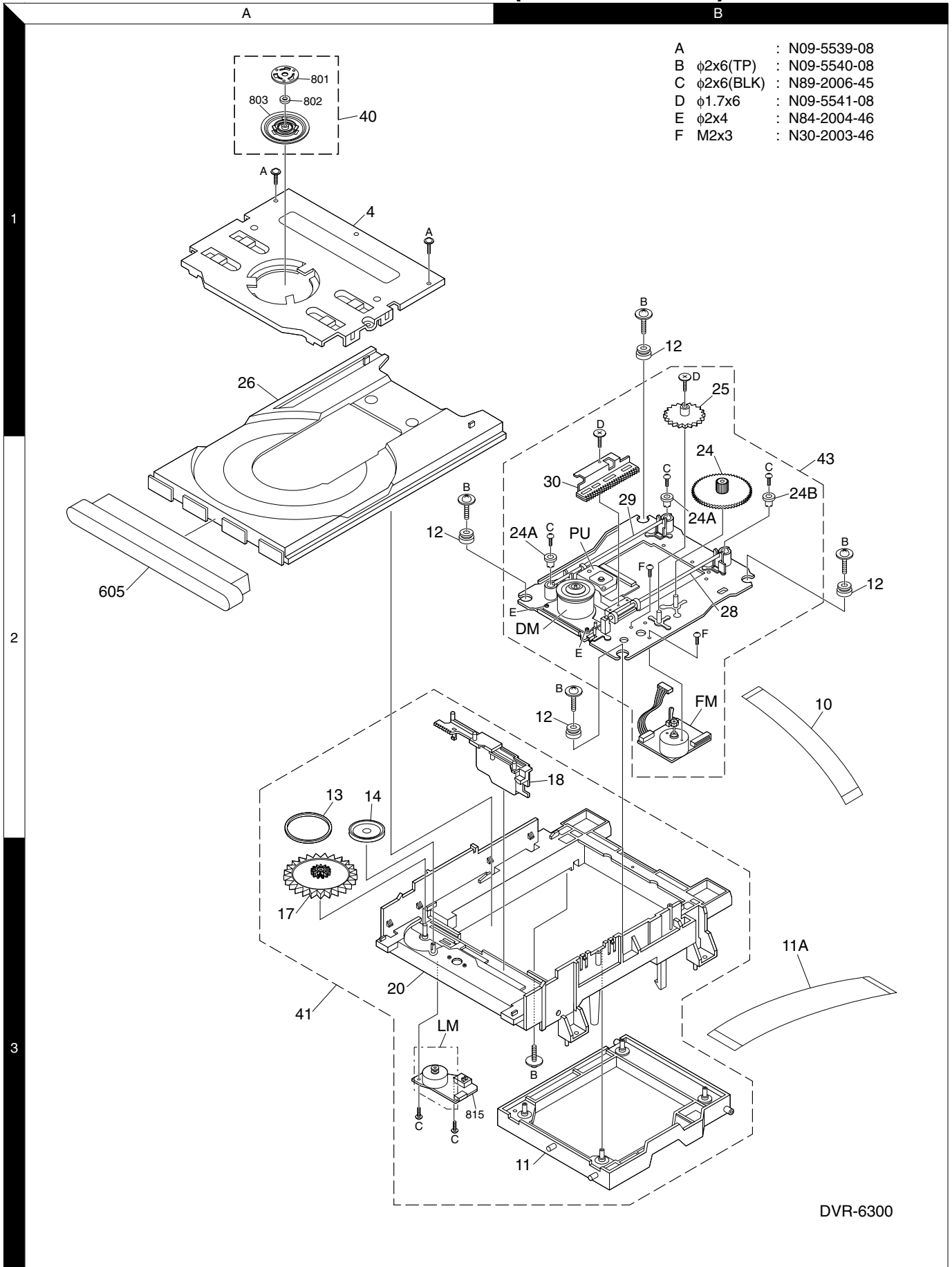

DVR-6300

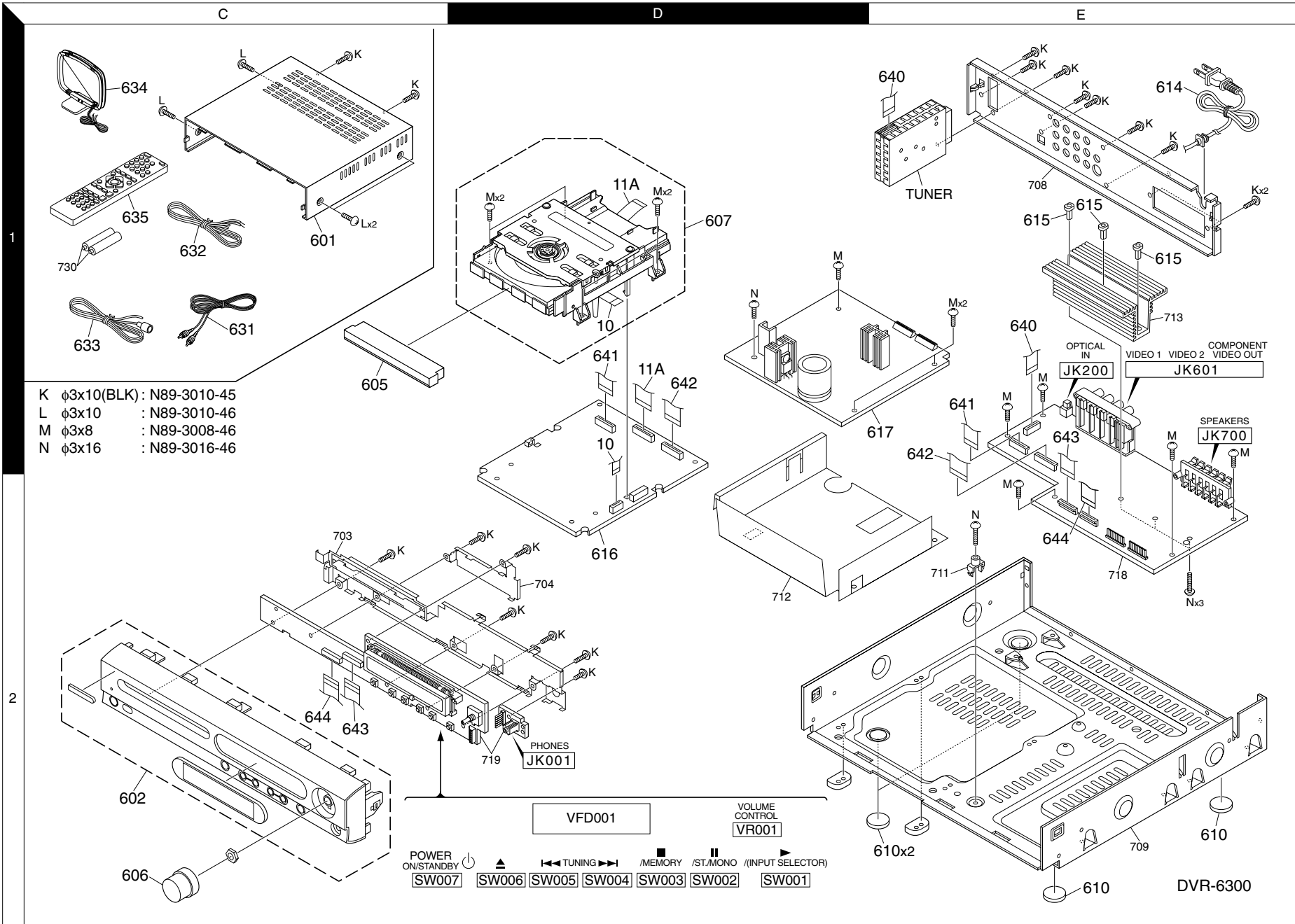

- K ϕ 3x10(BLK) : N89-3010-45
- L ϕ 3x10 : N89-3010-46
- M ϕ 3x8 : N89-3008-46
- N ϕ 3x16 : N89-3016-46

Parts with exploded numbers larger than 700 are not supplied.

* New Parts
Parts without **Parts No.** are not supplied.
Les articles non mentionnés dans le **Parts No.** ne sont pas fournis.
Teile ohne **Parts No.** werden nicht geliefert.

①

Ref. No	Address	New Parts	Parts No.	Description	Destination	Remarks
DVR-6300						
-		*	B60-5526-08	INSTRUCTION AS	3835RH0040B	K
-		*	B60-5527-08	INSTRUCTION AS	3835RH0040C	E
-		*	H10-7936-08	PACKING	3920RCE090A	
-		*	H50-4956-08	BOX	3890RCC143B	E
-		*	H50-4957-08	BOX	3890RCC143A	K
601	1C	*	A01-3942-08	CABINET	3090RCH004A	
602	2C	*	A60-2414-08	PANEL ASSEMBLY	3721RCM500A	E
602	2C	*	A60-2415-08	PANEL ASSEMBLY	3721RCM500C	K
605	2A,1C	*	A29-1243-08	DOOR	3580RCC055A	
606	2C	*	K29-8412-08	KNOB	4940RCV001A	
607	1D	*	D40-1841-08	DECK ASSEMBLY,	6721RJ0381C	
610	2E	*	G11-2960-08	RUBBER	5040R-5040A	
614	1E	*	E30-7338-08	POWER CORD	6410RAHK06A	K
614	1E	*	E30-7339-08	POWER CORD	6410RCHK06A	E
615	1E	*	J19-6431-08	HOLDER	4930R-0344A	
616	2D	*	W02-4592-08	PWB(PCB) ASSEM	6871R-7324B	
617	1E	*	W02-4593-08	PWB(PCB) ASSEM	6871R-9300A	E
617	1E	*	W02-4594-08	PWB(PCB) ASSEM	6871R-9300B	K
631	1C	*	E30-7341-08	CABLE,COAXIAL	6850R-PAA8F	
632	1C	*	T90-0915-08	ANTENNA,T	5010SCT001A	KPX
633	1C	*	T90-0916-08	ANTENNA,LEAD	563-655A	E
634	1C	*	T90-0917-08	ANTENNA,LOOP	5010R-L002B	
635	1C	*	A70-1685-08	REMOTE CONTROL	6710CDAL02A	
640	1E	*	E35-3733-08	CABLE,FLAT		
641	1D,1E	*	E35-3734-08	CABLE,FLAT		
642	1D,1E	*	E35-3735-08	CABLE,FLAT		
643	2C,1E	*	E35-3736-08	CABLE,FLAT		
644	2C,2E	*	E35-3737-08	CABLE,FLAT		
TUNER	1E	*	W02-4596-08	TUNER	6700FM0028B	E
TUNER	1E	*	W02-4597-08	TUNER	6700FM0029B	K
POWER SUPPLY						
C900		*	C91-1695-08	CAPACITO	1000PF 400WV	
C901,2		*	C91-1696-08	CAPACITO	470PF 400WV	
C904		*	C92-0281-08	ELECTRO	330UF 450WV	
C905		*	C91-1697-08	CERAMIC	0.01UF 630WV	
C907		*	CE04KW1H100M	ELECTRO	10UF 50WV	
C908		*	CE04KW1H470M	ELECTRO	47UF 50WV	
C909		*	C91-1698-08	CERAMIC	0.0047UF 100WV	
C910		*	C91-1699-08	CERAMIC	0.01UF 100WV	
C911		*	CE04KW1H470M	ELECTRO	47UF 50WV	
C912		*	C91-1700-08	CERAMIC	0.0027UF 100WV	
C913		*	C90-5833-08	CERAMIC	560PF 1KWV	
C914		*	C91-1701-08	CERAMIC	0.1UF 100WV	
C915		*	C91-1702-08	MYLAR	0.047UF 100WV	
C922		*	CE04KW1H2R2M	ELECTRO	2.2UF 50WV	
C923		*	CE04KW1A102M	ELECTRO	1000UF 10WV	
C924		*	CE04KW1E102M	ELECTRO	1000UF 25WV	
C925		*	CE04KW1A102M	ELECTRO	1000UF 10WV	
C926		*	CE04KW1E101M	ELECTRO	100UF 25WV	
C927		*	CE04KW1H101M	ELECTRO	100UF 50WV	
C928		*	CE04KW1A102M	ELECTRO	1000UF 10WV	
C929		*	CE04KW1E331M	ELECTRO	330UF 25WV	
C930		*	CE04KW1A102M	ELECTRO	1000UF 10WV	

L: Scandinavia K: USA P: Canada R: Mexico C: China I: Malaysia
Y: PX(Far East,Hawaii) T: England E: Europe G: Germany V: China(Shanghai)
Y: AAFES(Europe) X: Australia Q: Russia H: Korea M: Other Areas Δ indicates safety critical components.

* New Parts
Parts without **Parts No.** are not supplied.
Les articles non mentionnés dans le **Parts No.** ne sont pas fournis.
Teile ohne **Parts No.** werden nicht geliefert.

②

Ref. No	Address	New Parts	Parts No.	Description	Destination	Remarks
C932			CE04KW0J102M	ELECTRO	1000UF 6.3WV	
C933			CE04KW1C222M	ELECTRO	2200UF 16WV	
C934			CE04KW0J102M	ELECTRO	1000UF 6.3WV	
C935			CE04KW1C470M	ELECTRO	47UF 16WV	
C936			CE04KW1C101M	ELECTRO	100UF 16WV	
C937-40			CK45FB1H103K	CERAMIC	0.010UF K	
C941			CE04KW1C331M	ELECTRO	330UF 16WV	
C942			CE04KW1H2R2M	ELECTRO	2.2UF 50WV	
C943			CE04KW1H010M	ELECTRO	1.0UF 50WV	
C944			CE04KW1H100M	ELECTRO	10UF 50WV	
C951-3			CE04KW1H222M	ELECTRO	2200UF 50WV	
C954		*	C91-1703-08	CERAMIC	470PF 1KWV	
CM901,2		*	C91-1705-08	CAPACITOR	0.1UF	
FB901,2		*	L92-0828-08	FILTER(CIRC),E	636-004C	
L921-3		*	L33-1721-08	COIL,CHOKE	633-088G	
LF901		*	L33-1722-08	FILTER(CIRC),E	6200JB8013N	
T901		*	L07-3310-08	TRANSFORMER,SM	6170RNGW17E	
T902		*	L07-3311-08	TRANSFORMER,SM	6170RNGW17F	
R900		*	R92-4672-08	RD	1.5M J 1/2W	
R901		*	R92-4673-08	RS	56K J 2W	
R909,10		*	R92-4674-08	RS	470K J 2W	
VR901		*	SVR10D-471	VARISTOR	6102R2A002A	
BD901		*	GBU6J	DIODE,RECTIFIE	0DRFC00181A	
D901		*	EG01CW	DIODE,RECTIFIE	0DD010009CA	
D902,3		*	EU01W	DIODE,RECTIFIE	0DD010009AC	
D911		*	EU01W	DIODE,RECTIFIE	0DD010009AC	
D912		*	1SS133	DIODE,SWITCHIN	0DD133009AB	
D921		*	EU01W	DIODE,RECTIFIE	0DD010009AC	
D922		*	SB360	DIODE,RECTIFIE	0DRVH00030A	
D923		*	UG4D	DIODE,RECTIFIE	0DRVH00020A	
D924		*	SB360	DIODE,RECTIFIE	0DRVH00030A	
D926,7		*	EU01W	DIODE,RECTIFIE	0DD010009AC	
D928		*	1N4148	DIODE,SWITCHIN	0DS141489AB	
D929		*	1SS133	DIODE,SWITCHIN	0DD133009AB	
D932,3		*	1SS133	DIODE,SWITCHIN	0DD133009AB	
D941		*	EU01W	DIODE,RECTIFIE	0DD010009AC	
D942		*	1N5402	DIODE,RECTIFIE	0DD540200CA	
D951		*	FFPF20U20STU	DIODE,RECTIFIE	0DRFC00171A	
D951		*	FFPF30U20STU	DIODE,RECTIFIE	0DRFC00191A	
F901		*	F50-0260-08	FUSE,SLOW BLOW	0FS5001B51D	
IC901		*	KA5M0365R-YDTU	IC,POWER MANAG	0IPMGFA005A	
IC902		*	KA5Q1265RFYDTU	IC,POWER MANAG	0IPMGFA035A	
IC921		*	KA378R05-TSTU	IC,POWER MANAG	0IPMGFA006C	
IC922		*	KA78R12TSTU	IC,POWER MANAG	0IPMGFA017A	
IC923		*	KA78R33TSTU	IC,POWER MANAG	0IPMGFA015A	
IC924		*	KIA7808API-CU	IC,POWER MANAG	0IPMGKE009C	
IC941,2		*	KA431AZ	IC,SAMSUNG ELE	0ISS431000A	
PC910-2		*	LTV-817B	SENSOR	657-063A	
Q910		*	KTA1268	TRANSISTOR,BIP	0TR126809BA	
Q921		*	KTC3205	TRANSISTOR	0TR320509AB	
Q922		*	KTA1273	TRANSISTOR	0TR127309AA	
TH901		*	NTPAN4R0LDRB0	THERMISTOR,PTC	6322B62204A	
ZD911		*	GDZJ4.7B	DIODE,ZENER	0DZ470009AD	
ZD921		*	GDZJ12C	DIODE,ZENERS	0DZ120009AG	

L: Scandinavia K: USA P: Canada R: Mexico C: China I: Malaysia
Y: PX(Far East,Hawaii) T: England E: Europe G: Germany V: China(Shanghai)
Y: AAFES(Europe) X: Australia Q: Russia H: Korea M: Other Areas Δ indicates safety critical components.

PARTS LIST

DVR-6300

* New Parts

Parts without **Parts No.** are not supplied.Les articles non mentionnés dans le **Parts No.** ne sont pas fournis.Teile ohne **Parts No.** werden nicht geliefert.

③

Ref. No	Add-ress	New Parts	Parts No.	Description	Desti-nation	Re-marks
MAIN						
C101			CE04KW1H3R3M	ELECTRO	3.3UF	50VV
C102			CK45FB1H104K	CERAMIC	0.10UF	K
C103,4			CC73GCH1H330J	CHIP C	33PF	J
C105-7			CE04KW1A471M	ELECTRO	470UF	10VV
C108			CE04KW1C221M	ELECTRO	220UF	16VV
C109,10			CK73GB1H104K	CHIP C	0.10UF	K
C111,2			CE04KW1H010M	ELECTRO	1.0UF	50VV
C113,4			CK73GB1H682K	CHIP C	6800PF	K
C199,200			CK73GB1H104K	CHIP C	0.10UF	K
C201			CE04KW1A471M	ELECTRO	470UF	10VV
C202			CK73GB1H104K	CHIP C	0.10UF	K
C203			CE04KW1H100M	ELECTRO	10UF	50VV
C204			CK73GB1H104K	CHIP C	0.10UF	K
C205			CE04KW1H100M	ELECTRO	10UF	50VV
C206			CK73GB1H104K	CHIP C	0.10UF	K
C207			CE04KW1H2R2M	ELECTRO	2.2UF	50VV
C208			CK73GB1H104K	CHIP C	0.10UF	K
C209			CE04KW1A101M	ELECTRO	100UF	10VV
C210-12			CK73GB1H104K	CHIP C	0.10UF	K
C213,4			CE04KW1H4R7M	ELECTRO	4.7UF	50VV
C215			CK73GB1H104K	CHIP C	0.10UF	K
C216			CE04KW1H2R2M	ELECTRO	2.2UF	50VV
C217			CK73GB1H104K	CHIP C	0.10UF	K
C218			CE04KW1C470M	ELECTRO	47UF	16VV
C219			CK73GB1H104K	CHIP C	0.10UF	K
C297-9		*	C91-1692-08	CERAMIC	0.1UF	50VV
C300			CK73GB1H102K	CHIP C	1000PF	K
C301			CK73GB1H104Z	CHIP C	0.10UF	Z
C302-4			CK73GB1H103K	CHIP C	0.010UF	K
C305			CK73GB1H104Z	CHIP C	0.10UF	Z
C306-8			CK73GB1H103K	CHIP C	0.010UF	K
C309,10			CK73GB1H104Z	CHIP C	0.10UF	Z
C311,2			CK73GB1H103K	CHIP C	0.010UF	K
C313-5			CK73GB1H104Z	CHIP C	0.10UF	Z
C316-8			CK73GB1H103K	CHIP C	0.010UF	K
C319,20			CK73GB1H104Z	CHIP C	0.10UF	Z
C321,2			CK73GB1H473K	CHIP C	0.047UF	K
C323			CK73GB1H104Z	CHIP C	0.10UF	Z
C324			CE04KW1A101M	ELECTRO	100UF	10VV
C325			CK73GB1H104Z	CHIP C	0.10UF	Z
C326			CE04KW0J102M	ELECTRO	1000UF	6.3VV
C327			CK73GB1H104Z	CHIP C	0.10UF	Z
C328			CE04KW1C100M	ELECTRO	10UF	16VV
C329			CK73GB1H104Z	CHIP C	0.10UF	Z
C330			CE04KW1A221M	ELECTRO	220UF	10VV
C331,2			CE04KW1C100M	ELECTRO	10UF	16VV
C333			CE04KW1A221M	ELECTRO	220UF	10VV
C334,5			CE04KW1C100M	ELECTRO	10UF	16VV
C336,7			CK73GB1H104Z	CHIP C	0.10UF	Z
C338			CE04KW1A101M	ELECTRO	100UF	10VV
C339			CK73GB1H104Z	CHIP C	0.10UF	Z
C340			CE04KW1A471M	ELECTRO	470UF	10VV
C341,2			CK73GB1H104Z	CHIP C	0.10UF	Z

L : Scandinavia K : USA P : Canada R : Mexico C : China I : Malaysia
 Y : PX(Far East,Hawaii) T : England E : Europe G : Germany V : China(Shanghai)
 Y : AAFES(Europe) X : Australia Q : Russia H : Korea M : Other Areas Δ indicates safety critical components.

* New Parts

Parts without **Parts No.** are not supplied.Les articles non mentionnés dans le **Parts No.** ne sont pas fournis.Teile ohne **Parts No.** werden nicht geliefert.

④

Ref. No	Add-ress	New Parts	Parts No.	Description	Desti-nation	Re-marks
C501,2			CK73GB1H104Z	CHIP C	0.10UF	Z
C503,4			CC73GCH1H121J	CHIP C	120PF	J
C505			CK73GB1H104Z	CHIP C	0.10UF	Z
C506,7			CC73GCH1H121J	CHIP C	120PF	J
C508-11			CE04KW1H010M	ELECTRO	1.0UF	50VV
C512,3			CC73GCH1H101J	CHIP C	100PF	J
C515,6			CC73GCH1H101J	CHIP C	100PF	J
C517,8			CK73GB1H102K	CHIP C	1000PF	K
C520,21			CK73GB1H104Z	CHIP C	0.10UF	Z
C522,3			CE04KW1C221M	ELECTRO	220UF	16VV
C524,5			CE04KW1C101M	ELECTRO	100UF	16VV
C526,7			CC73GCH1H560J	CHIP C	56PF	J
C528,9			CC73GCH1H470J	CHIP C	47PF	J
C530-3			CK73GB1H391J	CHIP C	390PF	J
C535-8			CE04KW1V100M	ELECTRO	10UF	35VV
C544,5			CK73GB1H104Z	CHIP C	0.10UF	Z
C546,7			CE04KW1C221M	ELECTRO	220UF	16VV
C548,9			CE04KW1C100M	ELECTRO	10UF	16VV
C550,1			CC73GCH1H560J	CHIP C	56PF	J
C552,3			CC73GCH1H470J	CHIP C	47PF	J
C554-7			CK73GB1H391J	CHIP C	390PF	J
C561-4			CE04KW1V100M	ELECTRO	10UF	35VV
C583			CK73GB1H104Z	CHIP C	0.10UF	Z
C599			CK73GB1H104Z	CHIP C	0.10UF	Z
C600			CC73GCH1H101J	CHIP C	100PF	J
C601			CE04KW1C100M	ELECTRO	10UF	16VV
C602			CE04KW1C470M	ELECTRO	47UF	16VV
C603			CE04KW1C100M	ELECTRO	10UF	16VV
C604			CC73GCH1H101J	CHIP C	100PF	J
C605			CE04KW1C100M	ELECTRO	10UF	16VV
C606			CC73GCH1H101J	CHIP C	100PF	J
C607			CK73GB1H104Z	CHIP C	0.10UF	Z
C608			CE04KW1C470M	ELECTRO	47UF	16VV
C609-11			CE04KW1C471M	ELECTRO	470UF	16VV
C614,5			CC73GCH1H121J	CHIP C	120PF	J
C616			CK73GB1H104Z	CHIP C	0.10UF	Z
C617,8			CE04KW1H010M	ELECTRO	1.0UF	50VV
C619-23			CE04KW1A471M	ELECTRO	470UF	10VV
C690,1			CE04KW1C100M	ELECTRO	10UF	16VV
C692			CE04KW1C470M	ELECTRO	47UF	16VV
C698			CK73GB1H104Z	CHIP C	0.10UF	Z
C699		*	C91-1692-08	CERAMIC	0.1UF	50VV
C700,1			CE04KW1H222M	ELECTRO	2200UF	50VV
C710-4			CK73GB1H104K	CHIP C	0.10UF	K
C715		*	C90-5832-08	CERAMIC	1UF	Z
C716			CE04KW1H100M	ELECTRO	10UF	50VV
C717			CK73GB1H331J	CHIP C	330PF	J
C718,9			CK73GB1H104K	CHIP C	0.10UF	K
C725		*	C90-5832-08	CERAMIC	1UF	Z
C726			CE04KW1H100M	ELECTRO	10UF	50VV
C727			CK73GB1H331J	CHIP C	330PF	J
C728-34			CK73GB1H104K	CHIP C	0.10UF	K
C735		*	C90-5832-08	CERAMIC	1UF	Z
C736			CE04KW1H100M	ELECTRO	10UF	50VV
C737			CK73GB1H331J	CHIP C	330PF	J

L : Scandinavia K : USA P : Canada R : Mexico C : China I : Malaysia
 Y : PX(Far East,Hawaii) T : England E : Europe G : Germany V : China(Shanghai)
 Y : AAFES(Europe) X : Australia Q : Russia H : Korea M : Other Areas Δ indicates safety critical components.

* New Parts

Parts without **Parts No.** are not supplied.

Les articles non mentionnés dans le **Parts No.** ne sont pas fournis.

Teile ohne **Parts No.** werden nicht geliefert.

5

Ref. No	Add-ress	New Parts	Parts No.	Description	Desti-nation	Re-marks
C738,9		*	CK73GB1H104K	CHIP C	0.10UF	K
C745			C90-5832-08	CERAMIC	1UF	Z
C746			CE04KW1H100M	ELECTRO	10UF	50WV
C747			CK73GB1H331J	CHIP C	330PF	J
C748-54			CK73GB1H104K	CHIP C	0.10UF	K
C755			CE04KW1H100M	ELECTRO	10UF	50WV
C756		*	C90-5832-08	CERAMIC	1UF	Z
C765			CE04KW1H100M	ELECTRO	10UF	50WV
C766		*	C90-5832-08	CERAMIC	1UF	Z
C767			CK73GB1H331J	CHIP C	330PF	J
C768-74			CK73GB1H104K	CHIP C	0.10UF	K
C775			CE04KW1H100M	ELECTRO	10UF	50WV
C776		*	C90-5832-08	CERAMIC	1UF	Z
C777			CK73GB1H331J	CHIP C	330PF	J
C778		*	C91-1701-08	CERAMIC	0.1UF	100WV
C779		*	C91-1693-08	MYLAR	0.22UF	63WV
C785			CE04KW1H100M	ELECTRO	10UF	50WV
C786		*	C90-5832-08	CERAMIC	1UF	Z
C788		*	C91-1701-08	CERAMIC	0.1UF	100WV
C789		*	C91-1693-08	MYLAR	0.22UF	63WV
C811,2		*	C91-1701-08	CERAMIC	0.1UF	100WV
C813		*	C91-1694-08	MYLAR	0.47UF	50WV
C821,2		*	C91-1701-08	CERAMIC	0.1UF	100WV
C823		*	C91-1694-08	MYLAR	0.47UF	50WV
C831,2		*	C91-1701-08	CERAMIC	0.1UF	100WV
C833		*	C91-1694-08	MYLAR	0.47UF	50WV
C841,2		*	C91-1701-08	CERAMIC	0.1UF	100WV
C843		*	C91-1694-08	MYLAR	0.47UF	50WV
C861,2		*	C91-1701-08	CERAMIC	0.1UF	100WV
C863		*	C91-1694-08	MYLAR	0.47UF	50WV
C871		*	C91-1694-08	MYLAR	0.47UF	50WV
C888-99			CK73GB1H682K	CHIP C	6800PF	K
C973			CE04KW1H470M	ELECTRO	47UF	50WV
C974			CE04KW1H101M	ELECTRO	100UF	50WV
C975			CE04KW1A470M	ELECTRO	47UF	10WV
C981			CE04KW1H2R2M	ELECTRO	2.2UF	50WV
C982			CK73GB1H104Z	CHIP C	0.10UF	Z
C987			CK73GB1H103K	CHIP C	0.010UF	K
C989-91			CK73GB1H104K	CHIP C	0.10UF	K
JK200		*	W02-4590-08	JACK,FIBER OPT	6612K00010B	
JK601		*	E63-1366-08	JACK,RCA	6612JH004AC	
JK601		*	E63-1367-08	JACK,RCA	6612JH004AD	
JK602		*	E59-0001-08	JACK,RCA	6612R-K001E	
PN101			E41-1411-08	CONNECTOR (CIR	6630XE00123	
PN102			E41-1412-08	CONNECTOR (CIR	6630XE01224	
PN103			E41-1413-08	CONNECTOR (CIR	561-686L	
PN200			E41-1414-08	CONNECTOR (CIR	6630XE00126	
PN201			E41-1415-08	CONNECTOR (CIR	6630XE00120	
FB501-4		*	L92-0826-08	FILTER(CIRC),E	6200HJC901A	
FB505,6		*	L92-0827-08	FILTER(CIRC),E	6200HJC102A	
FB508,9		*	L92-0827-08	FILTER(CIRC),E	6200HJC102A	
FB601,2		*	L92-0827-08	FILTER(CIRC),E	6200HJC102A	
FB603-5		*	L92-0827-08	FILTER(CIRC),E	6200HJC102A	
FB606		*	L92-0827-08	FILTER(CIRC),E	6200HJC102A	

L : Scandinavia K : USA P : Canada R : Mexico C : China I : Malaysia
 Y : PX(Far East,Hawaii) T : England E : Europe G : Germany V : China(Shanghai)
 Y : AAFES(Europe) X : Australia Q : Russia H : Korea M : Other Areas Δ indicates safety critical components .

* New Parts

Parts without **Parts No.** are not supplied.

Les articles non mentionnés dans le **Parts No.** ne sont pas fournis.

Teile ohne **Parts No.** werden nicht geliefert.

6

Ref. No	Add-ress	New Parts	Parts No.	Description	Desti-nation	Re-marks
FB608-11		*	L92-0827-08	FILTER(CIRC),E	6200HJC102A	
FB612-6		*	L92-0827-08	FILTER(CIRC),E	6200HJC102A	
FB617		*	L92-0826-08	FILTER(CIRC),E	6200HJC901A	
L102-6		*	L92-0827-08	FILTER(CIRC),E	6200HJC102A	
L200		*	L92-0827-08	FILTER(CIRC),E	6200HJC102A	
L201		*	L92-0827-08	FILTER(CIRC),E	6200HJC102A	
L203		*	L33-1686-08	INDUCTOR,RADIA	0LR0102J025	
L204		*	L92-0827-08	FILTER(CIRC),E	6200HJC102A	
L208		*	L92-0827-08	FILTER(CIRC),E	6200HJC102A	
L210		*	L92-0827-08	FILTER(CIRC),E	6200HJC102A	
L300-5		*	L92-0827-08	FILTER(CIRC),E	6200HJC102A	
L309-11		*	L92-0827-08	FILTER(CIRC),E	6200HJC102A	
L601,2		*	L92-0827-08	FILTER(CIRC),E	6200HJC102A	
L700		*	L33-1718-08	COIL,CHOKE	6140RCC002A	
L710		*	L92-0827-08	FILTER(CIRC),E	6200HJC102A	
L711		*	L33-1719-08	COIL,RF	6140RCC007A	
L721		*	L33-1719-08	COIL,RF	6140RCC007A	
L730		*	L92-0827-08	FILTER(CIRC),E	6200HJC102A	
L731		*	L33-1719-08	COIL,RF	6140RCC007A	
L741		*	L33-1719-08	COIL,RF	6140RCC007A	
L750		*	L92-0827-08	FILTER(CIRC),E	6200HJC102A	
L761		*	L33-1719-08	COIL,RF	6140RCC007A	
L770		*	L92-0827-08	FILTER(CIRC),E	6200HJC102A	
L771		*	L33-1720-08	COIL,RF	6140RCC008A	
L781		*	L33-1720-08	COIL,RF	6140RCC008A	
X101		*	L77-2441-08	RESONATOR,CRYS	6212AA2983C	
X201		*	L77-2442-08	OSCILLATOR	6204R-HK01C	
JK700		*	E70-1003-08	TERMINAL BLOCK	664000009AA	
L202			RK73GB1J000J	CHIP R	0	J 1/16W
L203			RK73GB1J101J	CHIP R	100	J 1/16W
L205			RK73GB1J101J	CHIP R	100	J 1/16W
L209			RK73GB1J000J	CHIP R	0	J 1/16W
L306-8			RK73GB1J000J	CHIP R	0	J 1/16W
R100			RK73GB1J101J	CHIP R	100	J 1/16W
R101-7			RK73GB1J102J	CHIP R	1.0K	J 1/16W
R108			RK73GB1J103J	CHIP R	10K	J 1/16W
R109			RK73GB1J222J	CHIP R	2.2K	J 1/16W
R110			RK73GB1J103J	CHIP R	10K	J 1/16W
R111-7			RK73GB1J101J	CHIP R	100	J 1/16W
R118-21			RK73GB1J103J	CHIP R	10K	J 1/16W
R122			RK73GB1J100J	CHIP R	10	J 1/16W
R123,4			RK73GB1J103J	CHIP R	10K	J 1/16W
R125			RK73GB1J102J	CHIP R	1.0K	J 1/16W
R126			RK73GB1J103J	CHIP R	10K	J 1/16W
R128-30			RK73GB1J103J	CHIP R	10K	J 1/16W
R132-4			RK73GB1J103J	CHIP R	10K	J 1/16W
R135			RK73GB1J105J	CHIP R	1.0M	J 1/16W
R136			RK73GB1J100J	CHIP R	10	J 1/16W
R137			RK73GB1J103J	CHIP R	10K	J 1/16W
R138			RK73GB1J100J	CHIP R	10	J 1/16W
R140-5			RK73GB1J102J	CHIP R	1.0K	J 1/16W
R146			RK73GB1J181J	CHIP R	180	J 1/16W
R148			RK73GB1J103J	CHIP R	10K	J 1/16W
R149			RK73GB1J102J	CHIP R	1.0K	J 1/16W

L : Scandinavia K : USA P : Canada R : Mexico C : China I : Malaysia
 Y : PX(Far East,Hawaii) T : England E : Europe G : Germany V : China(Shanghai)
 Y : AAFES(Europe) X : Australia Q : Russia H : Korea M : Other Areas Δ indicates safety critical components .

PARTS LIST

DVR-6300

* New Parts
Parts without **Parts No.** are not supplied.
Les articles non mentionnés dans le **Parts No.** ne sont pas fournis.
Teile ohne **Parts No.** werden nicht geliefert.

7

Ref. No	Add-ress	New Parts	Parts No.	Description	Desti-nation	Re-marks
R150-3			RK73GB1J181J	CHIP R 180 J 1/16W		
R154,5			RK73GB1J473J	CHIP R 47K J 1/16W		
R156			RK73GB1J103J	CHIP R 10K J 1/16W		
R200			RK73GB1J470J	CHIP R 47 J 1/16W		
R201,2			RK73GB1J101J	CHIP R 100 J 1/16W		
R203			RK73GB1J471J	CHIP R 470 J 1/16W		
R204,5			RK73GB1J000J	CHIP R 0 J 1/16W		
R206			RK73GB1J101J	CHIP R 100 J 1/16W		
R207			RK73GB1J123J	CHIP R 12K J 1/16W		
R208-12			RK73GB1J101J	CHIP R 100 J 1/16W		
R213			RK73GB1J471J	CHIP R 470 J 1/16W		
R215			RK73GB1J000J	CHIP R 0 J 1/16W		
R216-8			RK73GB1J101J	CHIP R 100 J 1/16W		
R219,20			RK73GB1J243J	CHIP R 24K J 1/16W		
R221			RK73GB1J472J	CHIP R 4.7K J 1/16W		
R222			RK73GB1J101J	CHIP R 100 J 1/16W		
R224			RK73GB1J471J	CHIP R 470 J 1/16W		
R300-19			RK73GB1J101J	CHIP R 100 J 1/16W		
R322			RK73GB1J103J	CHIP R 10K J 1/16W		
R323			RK73GB1J100J	CHIP R 10 J 1/16W		
R324			RK73GB1J000J	CHIP R 0 J 1/16W		
R325			RK73GB1J100J	CHIP R 10 J 1/16W		
R326,7			RK73GB1J101J	CHIP R 100 J 1/16W		
R328,9			RK73GB1J000J	CHIP R 0 J 1/16W		
R330,1			RK73GB1J222J	CHIP R 2.2K J 1/16W		
R332,3			RK73GB1J101J	CHIP R 100 J 1/16W		
R334			RK73GB1J122J	CHIP R 1.2K J 1/16W		
R336,7			RK73GB1J000J	CHIP R 0 J 1/16W		
R338-40			RK73GB1J101J	CHIP R 100 J 1/16W		
R341-3			RK73GB1J103J	CHIP R 10K J 1/16W		
R344			RK73GB1J101J	CHIP R 100 J 1/16W		
R345			RK73GB1J103J	CHIP R 10K J 1/16W		
R501,2			RK73GB1J473J	CHIP R 47K J 1/16W		
R503,4			RK73GB1J474J	CHIP R 470K J 1/16W		
R505,6			RK73GB1J473J	CHIP R 47K J 1/16W		
R507,8			RK73GB1J474J	CHIP R 470K J 1/16W		
R521			RK73GB1J101J	CHIP R 100 J 1/16W		
R522			RK73GB1J470J	CHIP R 47 J 1/16W		
R523			RK73GB1J470J	CHIP R 47 J 1/16W		
R524			RK73GB1J101J	CHIP R 100 J 1/16W		
R525,6			RK73GB1J103J	CHIP R 10K J 1/16W		
R530			RK73GB1J103J	CHIP R 10K J 1/16W		
R531,2			RK73GB1J683J	CHIP R 68K J 1/16W		
R533			RK73GB1J103J	CHIP R 10K J 1/16W		
R534			RK73GB1J473J	CHIP R 47K J 1/16W		
R535,6			RK73GB1J103J	CHIP R 10K J 1/16W		
R537			RK73GB1J473J	CHIP R 47K J 1/16W		
R538			RK73GB1J103J	CHIP R 10K J 1/16W		
R539-42			RK73GB1J153J	CHIP R 15K J 1/16W		
R546,7			RK73GB1J103J	CHIP R 10K J 1/16W		
R549			RK73GB1J103J	CHIP R 10K J 1/16W		
R556			RK73GB1J330J	CHIP R 33 J 1/16W		
R557,8			RK73GB1J470J	CHIP R 47 J 1/16W		
R559			RK73GB1J330J	CHIP R 33 J 1/16W		
R560,1			RK73GB1J104J	CHIP R 100K J 1/16W		

L : Scandinavia K : USA P : Canada R : Mexico C : China I : Malaysia
Y : PX(Far East,Hawaii) T : England E : Europe G : Germany V : China(Shanghai)
Y : AAFES(Europe) X : Australia Q : Russia H : Korea M : Other Areas Δ indicates safety critical components .

* New Parts
Parts without **Parts No.** are not supplied.
Les articles non mentionnés dans le **Parts No.** ne sont pas fournis.
Teile ohne **Parts No.** werden nicht geliefert.

8

Ref. No	Add-ress	New Parts	Parts No.	Description	Desti-nation	Re-marks
R566,7			RK73GB1J683J	CHIP R 68K J 1/16W		
R568			RK73GB1J103J	CHIP R 10K J 1/16W		
R569			RK73GB1J473J	CHIP R 47K J 1/16W		
R570,1			RK73GB1J103J	CHIP R 10K J 1/16W		
R572			RK73GB1J473J	CHIP R 47K J 1/16W		
R573			RK73GB1J103J	CHIP R 10K J 1/16W		
R574-7			RK73GB1J153J	CHIP R 15K J 1/16W		
R578,9			RK73GB1J103J	CHIP R 10K J 1/16W		
R581			RK73GB1J103J	CHIP R 10K J 1/16W		
R582,3			RK73GB1J331J	CHIP R 330 J 1/16W		
R601			RK73GB1J750J	CHIP R 75 J 1/16W		
R602			RK73GB1J221J	CHIP R 220 J 1/16W		
R603,4			RK73GB1J750J	CHIP R 75 J 1/16W		
R605			RK73GB1J750J	CHIP R 75 J 1/16W		
R606,7			RK73GB1J102J	CHIP R 1.0K J 1/16W		
R608			RK73GB1J103J	CHIP R 10K J 1/16W		
R609			RK73GB1J222J	CHIP R 2.2K J 1/16W		
R610			RK73GB1J750J	CHIP R 75 J 1/16W		
R613			RK73GB1J750J	CHIP R 75 J 1/16W		
R616			RK73GB1J750J	CHIP R 75 J 1/16W		
R620			RK73GB1J473J	CHIP R 47K J 1/16W		
R621			RK73GB1J474J	CHIP R 470K J 1/16W		
R622			RK73GB1J473J	CHIP R 47K J 1/16W		
R623			RK73GB1J474J	CHIP R 470K J 1/16W		
R624			RK73GB1J152J	CHIP R 1.5K J 1/16W		
R711			RK73GB1J100J	CHIP R 10 J 1/16W		
R712			RK73GB1J000J	CHIP R 0 J 1/16W		
R713,4			RK73GB1J103J	CHIP R 10K J 1/16W		
R717,8			RK73GB1J5R6J	CHIP R 5.6 J 1/16W		
R727,8			RK73GB1J5R6J	CHIP R 5.6 J 1/16W		
R731			RK73GB1J100J	CHIP R 10 J 1/16W		
R732			RK73GB1J000J	CHIP R 0 J 1/16W		
R733,4			RK73GB1J103J	CHIP R 10K J 1/16W		
R737,8			RK73GB1J5R6J	CHIP R 5.6 J 1/16W		
R747,8			RK73GB1J5R6J	CHIP R 5.6 J 1/16W		
R751			RK73GB1J100J	CHIP R 10 J 1/16W		
R752			RK73GB1J000J	CHIP R 0 J 1/16W		
R753,4			RK73GB1J103J	CHIP R 10K J 1/16W		
R767,8			RK73GB1J5R6J	CHIP R 5.6 J 1/16W		
R771			RK73GB1J100J	CHIP R 10 J 1/16W		
R772			RK73GB1J000J	CHIP R 0 J 1/16W		
R773,4			RK73GB1J103J	CHIP R 10K J 1/16W		
R777-9			RK73GB1J5R6J	CHIP R 5.6 J 1/16W		
R787-9			RK73GB1J5R6J	CHIP R 5.6 J 1/16W		
R790,1			RK73GB1J000J	CHIP R 0 J 1/16W		
R799			RK73GB1J000J	CHIP R 0 J 1/16W		
SW101		*	S70-0031-05	SWITCH,TACT 556-219B		
D101-5		*	RL102-10C	DIODE,RECTIFIE 0DR102109AA		
D300		*	RL102-10C	DIODE,RECTIFIE 0DR102109AA		
D301			1SS133	DIODE,SWITCHIN 0DD133009AB		
D600			1SS133	DIODE,SWITCHIN 0DD133009AB		
D981			1SS133	DIODE,SWITCHIN 0DD133009AB		
IC101		*	LC876848C-53Z8	IC,MICRO CONTR 0IMCRSA092A		

L : Scandinavia K : USA P : Canada R : Mexico C : China I : Malaysia
Y : PX(Far East,Hawaii) T : England E : Europe G : Germany V : China(Shanghai)
Y : AAFES(Europe) X : Australia Q : Russia H : Korea M : Other Areas Δ indicates safety critical components .

* New Parts

Parts without **Parts No.** are not supplied.

Les articles non mentionnés dans le **Parts No.** ne sont pas fournis.

Teile ohne **Parts No.** werden nicht geliefert.



Ref. No	Add-ress	New Parts	Parts No.	Description	Desti-nation	Re-marks
IC201		*	AK5365VQ	IC, PERIPHERALS	0IPRPAK007A	
IC202		*	AK4117VF	IC, PERIPHERALS	0IPRPAK006A	
IC203		*	74VHC244MTCX	IC, FAIRCHILD	0IFA742440H	
IC301		*	PS9818	IC, POWER MANAG	0IPMGPV002A	
IC501		*	MC4580	IC, LINEAR	0ILNRUC001A	
IC503		*	MC4580	IC, LINEAR	0ILNRUC001A	
IC601		*	NJM2296M	IC, JRC	0IJR229600A	
△ IC710		*	STA505-5C	IC, PERIPHERALS	0IPRPSG009A	
△ IC730		*	STA505-5C	IC, PERIPHERALS	0IPRPSG009A	
△ IC750		*	STA501	IC, PERIPHERALS	0IPRPSG024A	
△ IC770		*	STA505-5C	IC, PERIPHERALS	0IPRPSG009A	
Q101			KRC103M	TRANSISTOR, BIP	0TR103009AE	
Q501.2			KTD1302	TRANSISTOR	0TR130209AA	
Q504.5			KTD1302	TRANSISTOR	0TR130209AA	
Q506			KRA102M	TRANSISTOR, BIP	0TR102009AE	
Q601			KTA1267	TRANSISTOR, BIP	0TR126709AB	
Q602		*	KTC3198	TRANSISTOR	0TR319809AC	
△ Q603-6		*	KRC103M	TRANSISTOR, BIP	0TR103009AE	
△ Q971		*	KTA1281Y	TRANSISTOR, BIP	0TR128109AA	
Q972		*	KTC3205	TRANSISTOR	0TR320509AB	
Q973		*	KTC3198	TRANSISTOR	0TR319809AC	
Q975		*	KTC3205	TRANSISTOR	0TR320509AB	
Q982		*	KRA103M	TRANSISTOR, BIP	0TR103009AF	
ZD601		*	GDZJ5.1B	DIODE, ZENER	0DZ510009AH	
ZD971		*	GDZJ33D	DIODE, ZENERS	0DZ330009AR	
ZD972		*	GDZJ8.2C	DIODE, ZENER	0DZ820009AG	
ZD973		*	GDZJ5.1B	DIODE, ZENER	0DZ510009AH	
ZD981		*	GDZJ4.7B	DIODE, ZENER	0DZ470009AD	
FRONT						
LD001		*	B30-2679-08	LED	0DLRH0049AA	
VFD001		*	HNVC12SM51T	DIGITRON	6302R-V209A	
C001.2			CK45FB1H102K	CERAMIC	1000PF K	
C003			CE04KW1A221M	ELECTRO	220UF 10WV	
C004.5		*	C91-1692-08	CERAMIC	0.1UF 50WV	
C006-8		*	C91-1704-08	CERAMIC	0.022UF K	
JK001		*	E11-0989-08	JACK, PHONE	6612R-A002A	
PN001			E41-1416-08	CONNECTOR (CIR	6630R-FB05W	
PN002			E41-1417-08	CONNECTOR (CIR	6630R-FB05X	
L001.2		*	L33-1723-08	INDUCTOR, AXIAL	0LA0102K019	
VR001		*	R31-0114-08	VOLUME, SLIDE	6110SFSU20B	
SW001-7		*	S70-0031-05	SWITCH, TACT	556-219B	
D001			1SS133	DIODE, SWITCHIN	0DD133009AB	
D004			1SS133	DIODE, SWITCHIN	0DD133009AB	
D005			1SS133	DIODE, SWITCHIN	0DD133009AB	
D006-9			1SS133	DIODE, SWITCHIN	0DD133009AB	
Q001			KRA103M	TRANSISTOR, BIP	0TR103009AF	
RMC001		*	W02-4591-08	REMOTE CONTROL	6712R1238GA	
DVD						
C5E0			CK73GB1H104K	CHIP C	0.10UF K	
C5A1			CE04KW1C100M	ELECTRO	10UF 16WV	
C5C1			CE04KW1C470M	ELECTRO	47UF 16WV	

L: Scandinavia K: USA P: Canada R: Mexico C: China I: Malaysia
 Y: PX(Far East, Hawaii) T: England E: Europe G: Germany V: China(Shanghai)
 Y: AAFES(Europe) X: Australia Q: Russia H: Korea M: Other Areas △ indicates safety critical components.

* New Parts

Parts without **Parts No.** are not supplied.

Les articles non mentionnés dans le **Parts No.** ne sont pas fournis.

Teile ohne **Parts No.** werden nicht geliefert.



Ref. No	Add-ress	New Parts	Parts No.	Description	Desti-nation	Re-marks
C5A2			CK73GB1H104K	CHIP C	0.10UF K	
C5C2			CE04KW1H1ROM	ELECTRO	1.0UF 50WV	
C5C4-7			CE04KW1H010M	ELECTRO	1.0UF 50WV	
C5C8			CK73GB1H104K	CHIP C	0.10UF K	
C5C9			CE04KW1C220M	ELECTRO	22UF 16WV	
C201			CK73GB1H104K	CHIP C	0.10UF K	
C202.3			CK73GB1H104K	CHIP C	0.10UF K	
C206			CE04KW1C101M	ELECTRO	100UF 16WV	
C207.8			CE04KW1C470M	ELECTRO	47UF 16WV	
C211-14			CK73GB1H104K	CHIP C	0.10UF K	
C231-34			CK73GB1H104K	CHIP C	0.10UF K	
C239			CK73GB1H104K	CHIP C	0.10UF K	
C240			CK45FB1H153K	CERAMIC	0.015UF K	
C241			CE04KW1C470M	ELECTRO	47UF 16WV	
C243.4			CK73GB1H561J	CHIP C	560PF J	
C245			CK73GB1H104K	CHIP C	0.10UF K	
C251-5			CK73GB1H104K	CHIP C	0.10UF K	
C257-61			CK73GB1A105Z	CHIP C	1.0UF Z	
C262.3			CK73GB1H104K	CHIP C	0.10UF K	
C264			CK73GB1H153K	CHIP C	0.015UF K	
C265-70			CK73GB1H104K	CHIP C	0.10UF K	
C271.2			CK73GB1H391J	CHIP C	390PF J	
C273			CK73GB1H333K	CHIP C	0.033UF K	
C274			CK73GB1H471K	CHIP C	470PF K	
C276			CC73GCH1H100D	CHIP C	10PF D	
C277			CK73GB1H153K	CHIP C	0.015UF K	
C278			CC73GCH1H270J	CHIP C	27PF J	
C279-83			CK73GB1H104K	CHIP C	0.10UF K	
C291			CE04KW1C101M	ELECTRO	100UF 16WV	
C292.3			CE04KW1C470M	ELECTRO	47UF 16WV	
C295			CE04KW1C100M	ELECTRO	10UF 16WV	
C296			CK73GB1H104K	CHIP C	0.10UF K	
C502-5			CK73GB1H103K	CHIP C	0.010UF K	
C506			CC73GCH1H101J	CHIP C	100PF J	
C507			CK73GB1H103K	CHIP C	0.010UF K	
C508		*	C90-5831-08	CERAMIC	2.2UF Z	
C509			CK73GB1H104K	CHIP C	0.10UF K	
C510			CC73GCH1H101J	CHIP C	100PF J	
C511			CE04KW1C470M	ELECTRO	47UF 16WV	
C513-5			CK73GB1H104K	CHIP C	0.10UF K	
C516		*	C90-5831-08	CERAMIC	2.2UF Z	
C517-27			CK73GB1H104K	CHIP C	0.10UF K	
C528			CE04KW1C470M	ELECTRO	47UF 16WV	
C530-2			CK73GB1H104K	CHIP C	0.10UF K	
C533			CC73GCH1H180J	CHIP C	18PF J	
C534			CC73GCH1H330J	CHIP C	33PF J	
C535			CK73GB1H104K	CHIP C	0.10UF K	
C536-8			CK73GB1H102K	CHIP C	1000PF K	
C539.40			CK73GB1H104K	CHIP C	0.10UF K	
C541			CE04KW1C100M	ELECTRO	10UF 16WV	
C542			CK73GB1H104K	CHIP C	0.10UF K	
C543			CE04KW1C100M	ELECTRO	10UF 16WV	
C544			CK73GB1H104K	CHIP C	0.10UF K	
C545			CE04KW1C100M	ELECTRO	10UF 16WV	
C554			CK73GB1H104K	CHIP C	0.10UF K	

L: Scandinavia K: USA P: Canada R: Mexico C: China I: Malaysia
 Y: PX(Far East, Hawaii) T: England E: Europe G: Germany V: China(Shanghai)
 Y: AAFES(Europe) X: Australia Q: Russia H: Korea M: Other Areas △ indicates safety critical components.

PARTS LIST

DVR-6300

* New Parts

Parts without **Parts No.** are not supplied.Les articles non mentionnés dans le **Parts No.** ne sont pas fournis.Teile ohne **Parts No.** werden nicht geliefert.

11

Ref. No	Add-ress	New Parts	Parts No.	Description	Desti-nation	Re-marks
C555			CE04KW1C100M	ELECTRO 10UF 16WV		
C556-61			CK73GB1H104K	CHIP C 0.10UF K		
C563,4			CE04KW0J221M	ELECTRO 220UF 6.3WV		
C567-9			CC73GCH1H221J	CHIP C 220PF J		
C575-82			CK73GB1H104K	CHIP C 0.10UF K		
C583			CE04KW0J221M	ELECTRO 220UF 6.3WV		
C589			CK73GB1H104K	CHIP C 0.10UF K		
C592			CK73GB1H104K	CHIP C 0.10UF K		
C637,8			CK73GB1H104K	CHIP C 0.10UF K		
C639			CE04KW0J221M	ELECTRO 220UF 6.3WV		
C640			CK73GB1H104K	CHIP C 0.10UF K		
C641			CE04KW0J221M	ELECTRO 220UF 6.3WV		
PDM01			E41-1411-08	CONNECTOR (CIR 6630XE00123		
PDA02			E41-1415-08	CONNECTOR (CIR 6630XE00120		
PDM02			E41-1409-08	CONNECTOR (CIR 6630XE00111		
PDA03			E41-1414-08	CONNECTOR (CIR 6630XE00126		
F502		*	L79-1305-08	FILTER(CIRC),E 6200JB8010V		
L5C1		*	L92-0827-08	FILTER(CIRC),E 6200HJC102A		
L201		*	L33-1686-08	INDUCTOR,RADIA 0LR0102J025		
L202		*	L92-0827-08	FILTER(CIRC),E 6200HJC102A		
L203		*	L33-1686-08	INDUCTOR,RADIA 0LR0102J025		
L204		*	L92-0827-08	FILTER(CIRC),E 6200HJC102A		
L231		*	L92-0827-08	FILTER(CIRC),E 6200HJC102A		
L251		*	L92-0827-08	FILTER(CIRC),E 6200HJC102A		
L264		*	L92-0827-08	FILTER(CIRC),E 6200HJC102A		
L265		*	L92-0827-08	FILTER(CIRC),E 6200HJC102A		
L501,2		*	L92-0827-08	FILTER(CIRC),E L92-0827-08		
L504		*	L92-0827-08	FILTER(CIRC),E L92-0827-08		
L603,4		*	L92-0827-08	FILTER(CIRC),E 6200HJC102A		
X501		*	L77-2439-08	RESONATOR,CRYS 6202R-BL06C		
L261			RK73GB1J000J	CHIP R 0 J 1/16W		
L262			RK73GB1J000J	CHIP R 0 J 1/16W		
R5C1			RK73GB1J151J	CHIP R 150 J 1/16W		
R5E1			RK73GB1J000J	CHIP R 0 J 1/16W		
R5C3-C6			RK73GB1J151J	CHIP R 150 J 1/16W		
R5A7			RK73GB1J103J	CHIP R 10K J 1/16W		
R5A9			RK73GB1J102J	CHIP R 1.0K J 1/16W		
R5C9			RK73GB1J000J	CHIP R 0 J 1/16W		
R6E1-E7			RK73GB1J000J	CHIP R 0 J 1/16W		
R201			RK73GB1J103J	CHIP R 10K J 1/16W		
R202			RK73GB1J104J	CHIP R 100K J 1/16W		
R203			RK73GB1J103J	CHIP R 10K J 1/16W		
R204			RK73GB1J104J	CHIP R 100K J 1/16W		
R205,6			RK73GB1J270J	CHIP R 27 J 1/16W		
R207-10			RK73GB1J000J	CHIP R 0 J 1/16W		
R211			RK73GB1J2R2J	CHIP R 2.2 J 1/16W		
R212			RK73GB1J754J	CHIP R 750K J 1/16W		
R213			RK73GB1J394J	CHIP R 390K J 1/16W		
R214			RK73GB1J754J	CHIP R 750K J 1/16W		
R215			RK73GB1J394J	CHIP R 390K J 1/16W		
R216			RK73GB1J1R0J	CHIP R 1 J 1/16W		
R217,8			RK73GB1J2R2J	CHIP R 2.2 J 1/16W		
R220,1			RK73GB1J270J	CHIP R 27 J 1/16W		

L : Scandinavia K : USA P : Canada R : Mexico C : China I : Malaysia

Y : PX(Far East,Hawaii) T : England E : Europe G : Germany V : China(Shanghai)

Y : AAFES(Europe) X : Australia Q : Russia H : Korea M : Other Areas Δ indicates safety critical components .

* New Parts

Parts without **Parts No.** are not supplied.Les articles non mentionnés dans le **Parts No.** ne sont pas fournis.Teile ohne **Parts No.** werden nicht geliefert.

12

Ref. No	Add-ress	New Parts	Parts No.	Description	Desti-nation	Re-marks
R231,2			RK73GB1J222J	CHIP R 2.2K J 1/16W		
R233,4			RK73GB1J2R2J	CHIP R 2.2 J 1/16W		
R235			RK73GB1J103J	CHIP R 10K J 1/16W		
R236			RK73GB1J153J	CHIP R 15K J 1/16W		
R237			RK73GB1J273J	CHIP R 27K J 1/16W		
R238-41			RK73GB1J103J	CHIP R 10K J 1/16W		
R242			RK73GB1J273J	CHIP R 27K J 1/16W		
R243			RK73GB1J103J	CHIP R 10K J 1/16W		
R244			RK73GB1J153J	CHIP R 15K J 1/16W		
R245,6			RK73GB1J103J	CHIP R 10K J 1/16W		
R251			RK73GB1J333J	CHIP R 33K J 1/16W		
R252			RK73GB1J104J	CHIP R 100K J 1/16W		
R253			RK73GB1J273J	CHIP R 27K J 1/16W		
R254,5			RK73GB1J000J	CHIP R 0 J 1/16W		
R256,7			RK73GB1J103J	CHIP R 10K J 1/16W		
R258,9			RK73GB1J000J	CHIP R 0 J 1/16W		
R501			RK73GB1J822J	CHIP R 8.2K J 1/16W		
R502			RK73GB1J754J	CHIP R 750K J 1/16W		
R503			RK73GB1J4R7J	CHIP R 4.7 J 1/16W		
R504			RK73GB1J000J	CHIP R 0 J 1/16W		
R505,6			RK73GB1J4R7J	CHIP R 4.7 J 1/16W		
R507			RK73GB1J182J	CHIP R 1.8K J 1/16W		
R508			RK73GB1J104J	CHIP R 100K J 1/16W		
R509,10			RK73GB1J000J	CHIP R 0 J 1/16W		
R511			RK73GB1J183J	CHIP R 18K J 1/16W		
R512			RK73GB1J104J	CHIP R 100K J 1/16W		
R513			RK73GB1J000J	CHIP R 0 J 1/16W		
R515-22			RK73GB1J330J	CHIP R 33 J 1/16W		
R523-6			RK73GB1J101J	CHIP R 100 J 1/16W		
R527			RK73GB1J472J	CHIP R 4.7K J 1/16W		
R528			RK73GB1J101J	CHIP R 100 J 1/16W		
R529			RK73GB1J000J	CHIP R 0 J 1/16W		
R534,5			RK73GB1J102J	CHIP R 1.0K J 1/16W		
R550-3			RK73GB1J000J	CHIP R 0 J 1/16W		
R564,5			RK73GB1J183J	CHIP R 18K J 1/16W		
R566,7			RK73GB1J103J	CHIP R 10K J 1/16W		
R570,1			RK73GB1J000J	CHIP R 0 J 1/16W		
R573-7			RK73GB1J000J	CHIP R 0 J 1/16W		
R578			RK73GB1J331J	CHIP R 330 J 1/16W		
R579-81			RK73GB1J000J	CHIP R 0 J 1/16W		
R616-21			RK73GB1J750J	CHIP R 75 J 1/16W		
R719-36			RK73GB1J000J	CHIP R 0 J 1/16W		
IC5A1		*	M29LV800TA-70	IC, MEMORIES 0IMMRFU010A		
IC5C1		*	MM1623XFBE	IC, PERIPHERALS 0IPRPM008A		
IC201		*	MT1336E	IC, LINEAR 0ILNRNF006A		
IC202		*	LA6560	IC, PERIPHERALS 0IPRPSA010A		
IC501		*	MT1379DEC	IC, LINEAR 0ILNRNF007B		
IC502,3		*	M12L16161A-7T	IC, MEMORIES 0IMMREB006C		
IC505		*	KS24C021CS	IC, SAMSUNG ELE 0ISS240210A		
Q201			KTC3875S	TRANSISTOR 0TR387509AC		
Q202,3			2SK3018	TRANSISTOR,BIP 0TRRH80042A		
Q204,5			2SA1037K	TRANSISTOR,BIP 0TR103709BB		
Q501			KTC3875S	TRANSISTOR 0TR387509AC		

L : Scandinavia K : USA P : Canada R : Mexico C : China I : Malaysia

Y : PX(Far East,Hawaii) T : England E : Europe G : Germany V : China(Shanghai)

Y : AAFES(Europe) X : Australia Q : Russia H : Korea M : Other Areas Δ indicates safety critical components .

* New Parts

Parts without **Parts No.** are not supplied.

Les articles non mentionnés dans le **Parts No.** ne sont pas fournis.

Teile ohne **Parts No.** werden nicht geliefert.



Ref. No	Add-ress	New Parts	Parts No.	Description	Desti-nation	Re-marks
MECHANISM						
4	1A	*	J19-6430-08	HOLDER	4930R-0402A	
10	2B	*	E35-3730-08	CABLE,FLAT	6850R-GK12A	
11	3B	*	A13-3230-08	FRAME	3210R-M002A	
11A	3B	*	E35-3731-08	CABLE,FLAT	6850R-JW14B	
12	2A,2B	*	J02-1571-08	RUBBER	5040R-0075D	
13	2A	*	D16-0805-08	BELT	4400R-0006B	
14	2A	*	D13-2651-08	GEAR	4470R-0055A	
17	3A	*	D13-2652-08	GEAR	4470R-0056A	
18	2B	*	J90-1402-08	GUIDE	4974R-0023A	
20	3A	*	A10-3622-08	BASE	3040R-D001A	
24	2B	*	D13-2653-08	GEAR	4470R-0131A	
24A	2B	*	B09-0910-08	CAP	5006R-0044A	
24B	2B	*	B09-0911-08	CAP	5006R-0043A	
25	1B	*	D13-2654-08	GEAR	4470R-0130A	
26	1A	*	J99-0854-08	TRAY	3390R-0012A	
28	2B	*	D21-2964-08	SHAFT	4370R-0082B	
29	2B	*	D21-2965-08	SHAFT	4370R-0082A	
30	2B	*	D13-2655-08	GEAR ASSEMBLY	4471R-0013D	
40	1A	*	J11-0903-08	CLAMP ASSEMBLY	4861R-0016D	
41	3A	*	A10-3623-08	BASE ASSEMBLY	3041R-M018A	
43	2B	*	D40-1840-08	BASE ASSEMBLY	3041R-M044D	
A		*	N09-5539-08	SCREW,DRAWING	1SZZR-0012A	
B		*	N09-5540-08	SCREW,DRAWING	1SZZH-1003A	
C		*	N89-2006-45	SCREW,DRAWING	1SZZH-1007B	
D		*	N09-5541-08	SCREW,DRAWING	1SZZR-0023B	
DM	2B	*	T42-1152-08	MOTOR(MECH)	4680R-C011A	
E		*	N84-2004-46	SCREW,DRAWING	1SZZR-0050A	
F		*	N30-2003-46	SCREW,DRAWING	1SZZR-0011A	
FM	2B	*	T42-1153-08	MOTOR ASSEMBLY	4681R-0034D	
LM	3A	*	T42-1154-08	MOTOR ASSEMBLY	4681R-1023G	
PU	2B	*	T25-0135-08	PICK UP,DVD	6716DPH005A	

HOW TO READ THE PARTS LIST

ABBREVIATION OF MODEL AND MASS PRODUCTION'S DESTINATIONS

MODEL	ABB.	Australia	Canada	Europe	PX/AAFES	USA
		X	P	E	-	K
DVR-6300	-	X	P	E	-	K

PARTS LIST

DVR-6300

L : Scandinavia **K** : USA **P** : Canada **R** : Mexico **C** : China **I** : Malaysia
Y : PX(Far East,Hawaii) **T** : England **E** : Europe **G** : Germany **V** : China(Shanghai)
Y : AAFES(Europe) **X** : Australia **Q** : Russia **H** : Korea **M** : Other Areas indicates safety critical components.

DVR-6300

SPECIFICATIONS

Speaker system (continued)

[KSW-7300]

(Front)

Enclosure Bass-Refrex (Magnetically shielded)
Speaker configuration 50 mm (2"), cone type X 2
Impedance 8 Ω
Power Handling Capacity (DVR-6300) 60 W
Dimensions W: 124 mm (4-7/8")
 H: maximum 337 mm (13-1/4")
 D: 150 mm (5-7/8")
Weight (net) 1.4 kg (3.1 lb)(1 piece, including the stand)

(Center)

Enclosure Bass-Refrex (Magnetically shielded)
Speaker configuration 50 mm (2"), cone type X 2
Impedance 8 Ω
Power Handling Capacity (DVR-6300) 60 W
Dimensions W: 210 mm (8-1/4")
 H: 80 mm (3-1/8")
 D: 98 mm (3-7/8")
Weight (net) 0.8 kg (1.8 lb)

(Surround)

Enclosure Bass-Refrex
Speaker configuration 50 mm (2"), cone type
Impedance 8 Ω
Power Handling Capacity (DVR-6300) 60 W
Dimensions W: 80 mm (3-1/8")
 H: 160 mm (6-5/16")
 D: 98 mm (3-7/8")
Weight (net) 0.4 kg (0.9 lb) (1 piece)

(Subwoofer)

Enclosure Bass-reflex type
Speaker configuration
 Woofer 160 mm (6-1/2"), cone type
Impedance 4 Ω
Power Handling Capacity (DVR-6300) 100 W
Dimensions W: 140 mm (5-1/2")
 H: 350 mm (13-3/4")
 D: 325 mm (12-13/16")
Weight (net) 4.0 kg (8.8 lb)

DVR-6300

SPECIFICATIONS

Main unit

[Amplifier section]

Effective output power during STEREO operation	
1 kHz, 10 % T.H.D. at 8 %	55 W + 55 W
Effective output power during SURROUND operation	
Front (1 kHz, 10 % T.H.D. at 8 %, one channel driven)	55 W + 55 W
Center (1 kHz, 10 % T.H.D. at 8 %, one channel driven)	55 W
Surround (1 kHz, 10 % T.H.D. at 8 %, one channel driven)	55 W + 55 W
Subwoofer (100 Hz, 10 % T.H.D. at 4 %, one channel driven)	100 W
Input sensitivity / impedance	
VIDEO 1 / VIDEO 2	650 mV / 47 k Ω
Output level / impedance	
VIDEO 1	1 V / 100 Ω

[Digital audio section]

Input level / impedance / wave length	
Optical (VIDEO1 / VIDEO2)	-21 dBm ~ -15 dBm, 660 nm

[Tuner section]

FM tuner section	
Tuning frequency range	87.5 MHz ~ 108 MHz
AM Tuner section	
Tuning frequency range (for Europe and Australia)	522 kHz ~ 1,611 kHz
Tuning frequency range (for U.S.A. and Canada)	530 kHz ~ 1,720 kHz

[DVD/CD/VIDEO CD player section]

Signal read system	Semiconductor laser
Video output format (for U.S.A. and Canada)	NTSC
Video output format (for Europe and Australia)	PAL/NTSC

[Video section]

input level / impedance	
VIDEO input (VIDEO 1 / VIDEO 2)	
Composite	1 Vp-p / 75 Ω
Output level / impedance	
VIDEO output (MONITOR OUT / VIDEO 1)	
Composite	1 Vp-p / 75 Ω
S-video output (MONITOR OUT)	
Y-signal	1 Vp-p / 75 Ω
C-signal	
NTSC	0.286 Vp-p / 75 Ω
PAL (for Europe and Australia)	0.300 Vp-p / 75 Ω
Component video output (MONITOR OUT)	
(for U.S.A. and Canada)	
Y-signal	1 Vp-p / 75 Ω
C _B / C _R -signal	0.7 Vp-p / 75 Ω
RGB output (SCAR T) (for Europe)	0.7 Vp-p / 75 Ω

[General]

Power consumption	70 W
Dimensions	W: 360 mm (14-3/16) H: 74 mm (2-15/16) D: 375 mm (14-13/16)
Weight (net)	4.4 kg (9.7 lb)

Speaker system

[KSW-6300]

(Front/Center)

Enclosure	Bass-Reflex (Magnetically shielded)
Speaker configuration	50 mm (2), cone type
Impedance	8 Ω
Power Handling Capacity (DVR-6300)	60 W
Dimensions	W: 80 mm (3-1/8) H: 160 mm (6-5/16) D: 98 mm (3-7/8)
Weight (net)	0.5 kg (1.1 lb)(1 piece)

(Surround)

Enclosure	Bass-Reflex
Speaker configuration	50 mm (2), cone type
Impedance	8 Ω
Power Handling Capacity (DVR-6300)	60 W
Dimensions	W: 80 mm (3-1/8) H: 160 mm (6-5/16) D: 98 mm (3-7/8)
Weight (net)	0.4 kg (0.9 lb) (1 piece)

(Subwoofer)

Enclosure	Bass-reflex type
Speaker configuration	
Woofer	160 mm (6-1/2), cone type
Impedance	4 Ω
Power Handling Capacity (DVR-6300)	100 W
Dimensions	W: 140 mm (5-1/2) H: 350 mm (13-3/4) D: 325 mm (12-13/16)
Weight (net)	4.0 kg (8.8 lb)



KENWOOD follows a policy of continuous advancements in development. For this reason specifications may be changed without notice.

- Sufficient performance may not be exhibited at extremely cold locations (Where water freezes).